

Report

**Community
Manure
Management
Feasibility Study**

Dane County, WI

February 2008

Report for
Dane County, Wisconsin

Community Manure Management
Feasibility Study

Prepared by:

STRAND ASSOCIATES, INC.®
910 West Wingra Drive
Madison, WI 53715
www.strand.com

February 2008



TABLE OF CONTENTS

Page No.
or Following

EXECUTIVE SUMMARY

SECTION 1–INTRODUCTION

1.01	Purpose and Scope of Report.....	1-1
1.02	Abbreviations and Acronyms	1-3

SECTION 2–CLUSTER IDENTIFICATION AND SURVEY RESULTS

2.01	Cluster Identification	2-1
2.02	Survey Questions and Discussion	2-2

SECTION 3–TECHNOLOGY REVIEW AND SHORT LIST

3.01	Literature Review and Farm Visit Summary	3-1
3.02	Alternatives For Study.....	3-16

SECTION 4–DESIGN BASIS AND FINANCIAL EVALUATIONS

4.01	Design Basis	4-1
4.02	Individual Farm Alternatives–Detailed Descriptions.....	4-2
4.03	Cluster Alternatives–Detailed Descriptions.....	4-5
4.04	Opinion of Capital Costs	4-11
4.05	Opinion of Operation and Maintenance (O&M) Costs	4-13
4.06	Annual O&M Sensitivity Analyses.....	4-19
4.07	Summary of Financial Evaluations.....	4-21

SECTION 5–NONMONETARY ISSUES EVALUATION

5.01	Nonmonetary Issues Review	5-1
5.02	Summary.....	5-6

SECTION 6–POTENTIAL FINANCIAL ASSISTANCE

6.01	Introduction	6-1
6.02	Local Sources	6-1
6.03	State of Wisconsin Sources	6-2
6.04	Federal Sources.....	6-4
6.05	Other Programs	6-8

SECTION 7–ALTERNATIVE BUSINESS STRUCTURES AND OWNERSHIP

7.01	Introduction	7-1
7.02	Individual Farm Ownership	7-1
7.03	Cooperative Ownership	7-1

TABLE OF CONTENTS Continued

	<u>Page No. or following</u>
7.04 Third-Party Ownership	7-2
7.05 Combination Co-op/Third Party Ownership	7-3
7.06 Government Ownership	7-3

SECTION 8–CONCLUSIONS AND RECOMMENDATIONS

8.01 Conclusions	8-1
8.02 Recommendations	8-2

APPENDICES

APPENDIX A–FARMER SURVEY
 APPENDIX B–UW PLATTEVILLE SUMMARY REPORT
 APPENDIX C–OPINION OF COSTS

TABLES

ES.04-1 Opinion of Capital Cost Summary.....	ES-3
ES.04-2 Opinion of Annual O&M Costs	ES-4
2.01-1 Cluster Statistics	2-1
3.01-1 Industrial Waste Streams.....	3-12
4.01-1 Preliminary Design Basis	4-1
4.04-1 Capital Cost Development	4-11
4.04-2 Opinion of Capital Cost Summary.....	4-12
4.05-1 O&M Unit Costs (2007).....	4-13
4.05-2 GHG Emission Reductions	4-16
4.05-3 Opinion of Annual O&M Costs.....	4-17
4.06-1 Individual Farms–O&M Cost Sensitivity Analyses	4-20
4.06-2 Waunakee Cluster–O&M Cost Sensitivity Analyses	4-20
4.06-3 Middleton Cluster–O&M Cost Sensitivity Analyses.....	4-20
5.01-1 Nonmonetary Issues Criteria	5-1
5.01-2 Monmonetary Scoring Summary	5-1
7.01-1 Comparison of Ownership Alternatives.....	7-1

FIGURES

ES.01-1 Upper Lake Mendota Watershed in Dane County	ES-1
1.01-1 Upper Lake Mendota Watershed in Dane County	1-1
2.01-1 Dane County Manure Management Survey–Potential Cluster Members ..	2-1

TABLE OF CONTENTS Continued

		<u>Page No. or following</u>
2.01-2	Survey Respondents in the Upper Mendota Watershed.....	2-1
2.02-1	Question 1–What Do You See as Your Greatest Farming Challenges Now and in Five Years?	2-3
2.02-2	Question 3–Animal Population Demographics	2-4
2.02-3	Question 5–What is Your Current Method of Manure Collection?	2-5
2.02-4	Question 7–What is Your Main Method for Applying Manure to the Land?	2-6
2.02-5	Question 8a–What is the Maximum Distance That You Now Haul Manure?	2-7
2.02-6	Question 8b–Would You Be Willing to Increase the Maximum Hauling Distance If a Manure Processing Station Were Available in Your Area?... ..	2-7
2.02-7	Question 11–How Many Labor Hours Are Spent Annually by You or Your Hired Help on the Manure Management Tasks?	2-9
2.02-8	Question 13–Level of Concern with Aspects of Manure Management	2-10
2.02-9	Question 16–Respondents and Interest Level.....	2-11
3.02-1	Alternative F-1.....	3-16
3.02-2	Alternative F-2.....	3-17
3.02-3	Alternative F-3.....	3-17
3.02-4	Alternative C-1	3-18
3.02-5	Alternative C-2	3-19
3.02-6	Alternative C-3	3-19
3.02-7	Alternative C-4	3-20
3.02-8	Alternative C-5	3-20
4.02-1	Alternative F-1.....	4-3
4.02-2	Alternative F-2.....	4-4
4.02-3	Alternative F-3.....	4-4
4.03-1	Alternative C-1W	4-7
4.03-2	Alternative C-1M	4-7
4.03-3	Alternative C-2W	4-8
4.03-4	Alternative C-2M	4-8
4.03-5	Alternative C-3W	4-9
4.03-6	Alternative C-3M	4-9
4.03-7	Alternative C-4W	4-10
4.03-8	Alternative C-4M	4-10
4.03-9	Alternative C-5W	4-10
4.03-10	Alternative C-5M	4-10

This section provides an overall summary of the report. For detailed information and discussion, please refer to the respective report sections.

ES.01 PURPOSE AND SCOPE OF REPORT

This study examines the feasibility of various community or individual farm-based manure management alternatives in the Upper Lake Mendota Watershed area of Dane County, Wisconsin. The study area is shown in Figure ES.01-1. The main goals of the study are to strengthen the livestock industry in the County and protect water quality as related to manure management. The scope of this study included the following elements: (1) survey of area farms, (2) selection of farms to include in the analyses, (3) identification and selection of management alternatives to be studied, (4) technical and

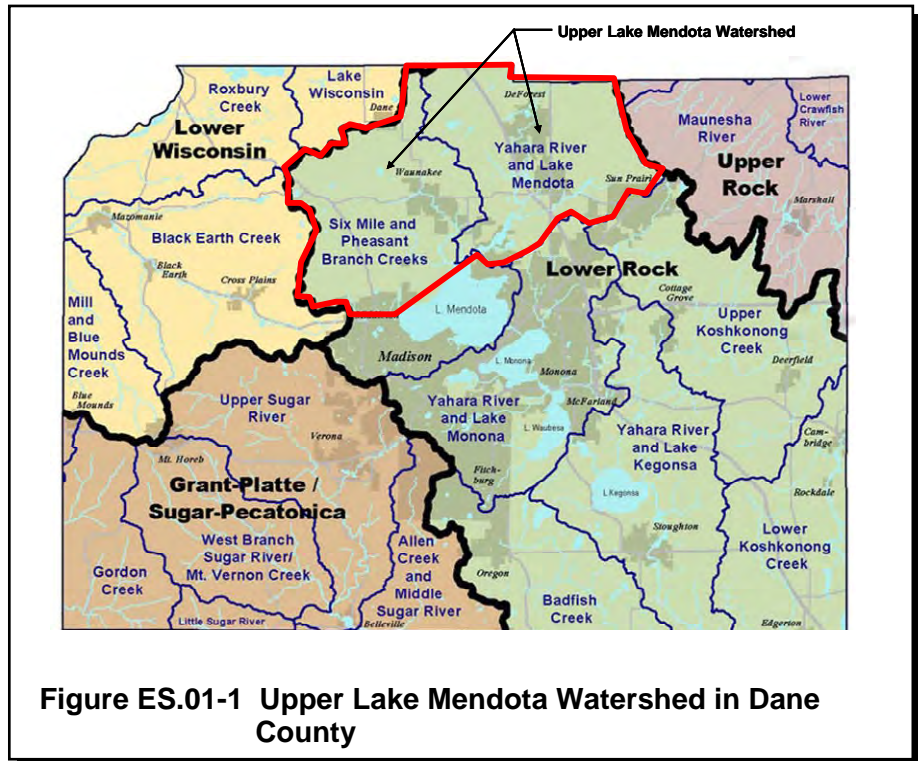

Figure ES.01-1 Upper Lake Mendota Watershed in Dane County

economic analyses of the alternatives, (5) discussion of nonmonetary evaluation of the alternatives, (6) potential financing methods, and (7) business structures for the recommended project(s).

ES.02 CLUSTER IDENTIFICATION AND SURVEY RESULTS

A questionnaire was developed and sent to 117 Dane County farmers in the Upper Lake Mendota watershed to collect information on farming operations and manure management practices in the area. Forty-one farmers responded with useful information. The survey responses were used to identify and select the two clusters (see Figure 2.01-2, Waunakee Cluster and Middleton Cluster) evaluated in this report, and the data collected was used to develop the design bases for the manure management alternatives. Detailed discussion of the clusters, as well as responses to the 16 survey questions, are provided in Section 2.

The Waunakee Cluster includes three farms with a total of approximately 3,145 animal units (A.U.). The farms are located within approximately one-half mile of each other, and additional farms are located nearby. The Middleton Cluster includes seven farms with a total A.U. of approximately 3,813. The Middleton Cluster farms are farther apart from each other than the Waunakee Cluster Farms.

ES.03 TECHNOLOGY REVIEW AND SELECTION OF MANAGEMENT ALTERNATIVES

A review of the status of the various manure management technologies is included in Section 3. The review is focused on viable technologies for manure solids destruction, manure solids separation, and phosphorus removal and recovery from manure. Eight management alternatives were then selected for further study based on the status of technology, potential viability, and ability to meet the project goals, the most significant of which is to reduce the manure-related phosphorus loading to the area lands by at least 40 percent. Three of the eight alternatives are for application at individual farms (F-1 through F-3), and the remaining five alternatives are community solutions that could be applied at the Waunakee or Middleton Clusters (C-1 through C-5). These alternatives are listed below:

- F-1. Fine solids separation with polymer addition.
- F-2. Fine solids separation with ferric chloride and polymer addition.
- F-3. Anaerobic digestion; solids separation with ferric chloride and polymer addition.
- C-1. Fine solids separation with polymer addition.
- C-2. Fine solids separation with ferric chloride and polymer addition.
- C-3. Anaerobic digestion; solids separation with ferric chloride and polymer addition.
- C-4. Fine solids separation with ferric chloride and polymer addition; drying.
- C-5. Drying followed by combustion.

ES.04 OPINION OF COSTS COMPARISONS AND SENSITIVITY ANALYSES

Detailed discussion of the preliminary design criteria and design bases are presented in Chapter 4. The capital costs of the alternatives were developed assuming each facility would be constructed with a capacity to handle the existing manure from the farms, plus the anticipated growth of the farms over the next five years, plus a reserve capacity equal to 25 percent of the anticipated manure loadings. The annual operation and maintenance (O&M) costs were developed using only the current and anticipated manure loadings, which does not include the 25 percent reserve capacity. This latter design basis was used to develop mass flow diagrams for each of the alternatives, which are included in Figures 4.02-1 through 4.02-3 and Figures 4.03-1 through 4.03-10. The opinion of capital costs and annual O&M costs were developed for each of the eight alternatives and are summarized in Table ES.04-1 and ES.04-2, respectively. Total cost opinions are presented as well as costs per animal unit and cost per pound of phosphorus removed. At this feasibility level of detail, all opinions of costs should be considered preliminary and have an approximate confidence level of +/- 25 percent.

Alternative	P Removed (%)	Capital Costs		
		Total	Per Current A.U.	Per Design A.U.
<u>Individual Farm^a</u>				
F-1	45%	\$1,426,000	\$2,850	\$2,130
F-2	85%	\$1,685,000	\$3,370	\$2,510
F-3	85%	\$2,840,000	\$5,680	\$4,240
<u>Waunakee Cluster^b</u>				
C-1W	45%	\$6,423,000	\$2,040	\$1,500
C-2W	85%	\$8,415,000	\$2,680	\$1,960
C-3W	85%	\$11,495,000	\$3,660	\$2,680
C-4W	90%	\$13,507,000	\$4,300	\$3,150
C-5W	100%	\$11,333,000	\$3,600	\$2,640
<u>Middleton Cluster^c</u>				
C-1M	45%	\$5,127,000	\$1,340	\$1,030
C-2M	85%	\$8,215,000	\$2,150	\$1,660
C-3M	85%	\$10,934,000	\$2,870	\$2,210
C-4M	90%	\$13,247,000	\$3,470	\$2,670
C-5M	100%	\$10,319,000	\$2,710	\$2,080

^a Current A.U. = 500; design A.U. = 669.
^b Current A.U. = 3,145; design A.U. = 4,293.
^c Current A.U. = 3,813; design A.U. = 4,957.
^d The opinion of costs are considered +/- 25 percent at this time.

Table ES.04-1 Opinion of Capital Cost Summary^d

Based on capital cost comparisons, the cluster alternatives are considerably less expensive than the individual farm alternatives when compared on the bases of “per animal unit” for similar technologies (e.g., comparing F-3 with C-3W and C-3M). The Middleton Cluster has lower “per A.U.” capital costs, which is the result of the pumping and piping infrastructure included in the Waunakee Cluster and not in the Middleton Cluster (see Chapter 3).

Alternative	P Removed (%)	Opinion of Net Annual O&M Expense (Revenue)			
		Year 2007	Year 2012	Year 2012 + 25% (design A.U.)	Per A.U. (2007)
Individual Farm^a					
Existing	0%	\$82,000	\$93,000	\$107,000	\$164
F-1	45%	\$152,000	\$165,000	\$193,000	\$304
F-2	85%	\$53,000	\$47,000	\$48,000	\$106
F-3	85%	\$82,000	\$78,000	\$80,000	\$164
Waunakee Cluster^b					
Existing	0%	\$936,000	\$1,059,000	\$1,218,000	\$298
C-1W	45%	\$1,007,000	\$1,086,000	\$1,291,000	\$320
C-2W	85%	\$98,000	\$20,000	(\$13,000)	\$31
C-3W	85%	(\$220,000)	(\$350,000)	(\$480,000)	(\$70)
C-4W	90%	\$884,000	\$890,000	\$1,072,000	\$281
C-5W	100%	(\$183,000)	(\$296,000)	(\$409,000)	(\$58)
Middleton Cluster^c					
Existing	0%	\$682,000	\$772,000	\$926,000	\$179
C-1M	45%	\$946,000	\$1,031,000	\$1,222,000	\$248
C-2M	85%	\$600,000	\$612,000	\$701,000	\$157
C-3M	85%	\$304,000	\$268,000	\$271,000	\$80
C-4M	90%	\$1,144,000	\$1,210,000	\$1,451,000	\$300
C-5M	100%	\$235,000	\$199,000	\$193,000	\$62

^a Year 2007 A.U. = 500; Year 2012 A.U. = 535; design A.U. = 669.
^b Year 2007 A.U. = 3,145; Year 2012 A.U. = 3,434; design A.U. = 4,293.
^c Year 2007 A.U. = 3,813; Year 2012 A.U. = 3,966; design A.U. = 4,957.
^d O&M costs do not include the cost for any commercial fertilizer required to replace manure-based fertilizer not applied to the soil in any of the alternatives.

Table ES.04-2 Opinion of Annual O&M Costs^d

The annual O&M cost opinions show similar results, especially for the Waunakee Cluster compared to the individual farm alternatives. The Middleton Cluster alternatives have a less significant O&M cost advantage over the individual farm alternatives, which is a result of the long haul distances from the farms to the centralized cluster facility. Additional observations were made:

1. For the individual farm alternatives, only Alternative F-2–Fine solids removal with polymer and ferric addition appears to lower annual O&M costs significantly compared to the existing O&M cost opinions.

2. For the cluster alternatives, the Waunakee cluster appears to have significantly lower annual O&M costs than the Middleton cluster. This is mainly because in the Waunakee cluster, manure and returned liquids are pumped to and from the cluster site, whereas in the Middleton cluster the manure and returned liquids are transported by truck.
3. For the Waunakee cluster, all the alternatives except C-1W (solids separation) and C-4W (drying) are anticipated to lower annual O&M costs significantly compared to the existing farms' O&M costs. The reason that Alternative C-1W is not anticipated to lower annual O&M costs for the farms in that cluster is that, because of the relatively lower solids and phosphorus removal achieved by this technology, the nutrient level of the liquids returned to the farms will still require trucking to the land, which has a higher O&M cost than pumping to land application fields. Alternative C-4W has a high annual cost for natural gas.
4. For the Waunakee cluster, the options that include energy recovery (Alternatives C-3W and C-5W) appear to generate net revenue. That is, the preliminary estimate of revenue streams (sale of solids, electricity buy-back, and greenhouse gas (GHG) emission reduction credits) exceeds the annual costs to operate the facilities. In addition, as the amount of manure handled increases, the net revenue appears to increase.
5. For the Middleton cluster, only the alternatives with energy recovery (Alternatives C-3M and C-5M) appear to lower annual O&M costs to a significant degree compared to the existing farms' collective O&M costs.
6. For the anaerobic digestion (C-3W) and combustion (C-5W) alternatives for the Waunakee Cluster, the amount of electrical generation potential is approximately 9,700 kWh/day and 13,100 kWh/day, respectively. This is equivalent to the amount of power used by approximately 415 and 560 homes, respectively, with an average energy use of 700 kWh/month.
7. Similarly, for the Middleton Cluster Alternatives C-3M and C-5M, the amount of electrical generation potential is approximately 7,300 kWh/day and 9,800 kWh/day, respectively, which is equivalent to the amount of power used by approximately 313 and 420 homes, respectively.
8. On a preliminary basis, the maximum potential GHG emissions reduction from eliminating long-term lagoon storage of the manure is estimated at approximately 19,800 metric tons/year of equivalent CO₂ for Alternatives C-3W and C-5W (Table 4.05-2). This is approximately equivalent to:

- a. The CO₂ emissions from the annual electrical generation to supply 3,800 homes using 700 kWh/month of electricity (1 kWh of electricity ~ 1.37 lbs CO₂).
- b. The CO₂ emissions from the annual natural gas use of 3,900 homes using 80 therms of natural gas/month (1 MMBTU of natural gas ~ 117 lbs CO₂).
- c. The CO₂ emissions from driving approximately 50 million miles/year at an average fuel economy of 25 miles/gallon (1 gallon of gasoline ~ 21.7 lbs CO₂).

O&M sensitivity analyses were developed for three main factors: manure/returned liquids hauling costs, solids disposal revenue, and GHG emission reduction credits. These were selected because of the significant impact these factors have on the overall O&M cost opinions as well as the relative difficulty in predicting the costs or value of these factors in the future. The base conditions for the sensitivity analyses are 2007 conditions and unit costs. Tables 4.06-1, 4.06-2, and 4.06-3 present the analyses.

ES.05 NONMONETARY ISSUES EVALUATION

Important nonmonetary issues were selected following a review of the Dane County Manure Feasibility Study Committee's goals and issues included in the County's request for proposals. The relative importance of each nonmonetary issue was then established with input from members of the Manure Management Committee and others having knowledge of the issues. Descriptions of the nonmonetary issues and criteria for scoring are provided in Table 5.01-1; weighting factors and scores are provided in Table 5.01-2. The two anaerobic digestion alternatives have the highest nonmonetary scores, with Alternative C-3 (cluster anaerobic digestion) having the highest overall score of 73 and Alternative F-3 (individual farm anaerobic digestion) having a score of 61. The alternatives with fine solids separation and ferric chloride addition, Alternatives F-2 and C-2, were rated the next highest with scores of 50 and 45, respectively. The remaining alternatives were all assigned similar scores of 37 or 38.

ES.06 POTENTIAL FINANCIAL ASSISTANCE

A range of financial assistance opportunities for manure management projects is available from local, state, and federal sources. However, the financing and financial aid opportunities for a manure management project are dependent on several factors, particularly the type of ownership, financial need, and type of project. For example, farmer-owned facilities may be more eligible for certain grants than a venture capital investment firm-owned facility. Likewise, a renewable energy project (e.g., anaerobic digestion, manure combustion) is likely to be more eligible for grants than a project that simply separates solids to improve nutrient management.

It is important to realize that financial assistance programs for manure management projects are constantly evolving and new programs are being developed. In addition, the existing programs may be modified, expanded, or discontinued in the future. Chapter 6 presents a summary of programs currently available from known local, state, and federal sources.

ES.07 ALTERNATIVE BUSINESS STRUCTURES AND OWNERSHIP

A detailed discussion of potential business structures and/or ownership of a manure management facility is beyond the scope of this report. However, Chapter 7 does present a discussion of several ownership options, including individual farm ownership, cooperative ownership, third-party ownership, combination third-party/cooperative ownership, and government ownership. The discussion is focused on the ownership and potential business structure of a community or joint/cluster manure management facility. However, some of the potential ownership alternatives are applicable to single-farm installations of manure management equipment and systems. Table 7.01-1 presents a summary of this discussion, including advantages and disadvantages of each.

ES.08 CONCLUSIONS AND RECOMMENDATIONS

Chapter 8 of the report presents the main conclusions of the report and recommended next steps to move from this feasibility analysis to detailed planning. The following conclusions are provided to summarize the conclusions drawn in this report and to provide the bases for our recommendations:

- There is a great deal of interest from the Dane County farming community to develop manure management strategies. Manure management at many Dane County farms requires long hauling distances and land rental for land application of the manure at agronomic rates.
- Water quality impacts from land application of manure have been shown to be significant, and manure is a major source of phosphorus loading (and other nutrient loading) within the Upper Lake Mendota Watershed.
- Cluster manure management strategies appear to offer significant economies of scale with respect to capital costs compared to the individual farm systems. In general, while comparing similar manure management strategies, the capital cost projections of the cluster systems are approximately 50 to 75 percent of the capital cost of the individual farm systems when compared on a “per A.U.” basis.
- Some of the cluster management strategies have significantly lower annual O&M cost projections (per A.U. basis) than the existing annual O&M costs at the farms as well as the individual farm manure management strategies. In particular, Waunakee Cluster Alternatives C-2W, C-3W, and C-5W, and the Middleton Cluster Alternatives C-3M and C-5M could significantly reduce annual O&M costs and may generate net revenues for the farms.
- The Waunakee Cluster strategies have higher capital costs compared to the Middleton Cluster, which is mainly the result of the added infrastructure required to pump manure to the cluster management facilities rather than trucking the manure. However, because manure trucking is essentially eliminated for the Waunakee Cluster, the projected

annual O&M costs are much lower for the Waunakee Cluster compared to the Middleton Cluster.

- Given the proximity of the Waunakee Cluster farms to each other and the potential to pump manure rather than haul manure to the site, the Waunakee Cluster alternatives appear to offer more advantages and better long-term cost-effectiveness than the Middleton Cluster alternatives or individual farm alternatives. There may be other small clusters similar to the Waunakee Cluster that could also be identified.

The following recommendations are provided to indicate what additional steps should be taken to further define how best to implement such a project.

1. Continue discussions and information exchange with area Dane County farmers to assess on-going interest and promote community solutions.
2. At the County level, determine what level of financial commitment is reasonable to invest in the additional planning, design, and ultimate construction of a manure management strategy.
3. At the County level, discuss and determine whether such a facility could or should be owned and operated by the County. This may be affected by the level of interest in ownership among farmers.
4. Conduct a Facility Planning Study to further refine and develop the scope of select alternatives and strategies included in this report with a focus on the alternatives that appear most viable (C-2W, C-3W, and C-5W). This includes identifying potential site locations, verifying manure quantities and other potential feedstocks, working with system vendors to develop preliminary layout(s) of alternatives and more accurate cost opinions (capital and O&M), and conducting a detailed analysis of overall manure management practices on the affected farms. The output of this study would include an overall recommended manure management strategy and associated costs, which could then be used to better define potential ownership of the facility, operation of the facility, and funding programs that could help finance a project to construct the facility. The Facility Planning Report would provide much better definition of the project and costs to provide to interested third-party technology developers, farmers, and County officials.
5. Define agronomic and related crop management impacts that would result from a manure management facility, and include such impacts in the facility planning analyses.
6. Continue to investigate funding and financing opportunities for manure management facilities.

7. Investigate potential GHG emission reduction credits in more detail and determine what additional steps are needed to obtain maximum credit for such a project.
8. Evaluate the capital and O&M costs from actual full-scale operations in the United States, and estimate how those costs may translate to a similar operation in Dane County.

Regardless of how integral the County is in developing a manure management facility, and regardless of who owns and operates the facility, we recommend that the County maintain involvement throughout the planning, design, construction, and operation of the facility.

SECTION 1
INTRODUCTION

This section describes the purpose and scope of the Manure Management Feasibility Study and the location of the study area. A list of definitions and abbreviations is provided as an aid to the reader.

1.01 PURPOSE AND SCOPE OF REPORT

This study examines the feasibility of various community or individual farm-based manure management alternatives in the Upper Lake Mendota Watershed area of Dane County, Wisconsin. The study area is shown in Figure 1.01-1.

Dane County (“the County”) has multiple goals related to the management of manure and numerous issues that need to be considered when meeting the goals. Several goals and issues were developed by the County’s Community Manure Feasibility Study Committee and were summarized in the Request for Proposals for this study. The main goal is to both strengthen the livestock industry in the County while protecting water quality as related to manure management. Water quality concerns are currently addressed to some extent through the County’s nitrogen (N), phosphorus (P), and potassium (K) nutrient management requirements for land application. At many locations within the study area, however, phosphorus is already present in soils at concentrations exceeding crop fertilizer recommendations (generally around 100 mg/kg for corn). Nutrient-rich soils are a water quality concern because the soils can enter waterways during wet weather or snow melt events that cause runoff. Nutrients can enter waterways more directly if solid or liquid manure is spread too close to drainageways or surface waters. Once in waterways, nutrients contribute to algal growth and associated poor water quality and aesthetics.

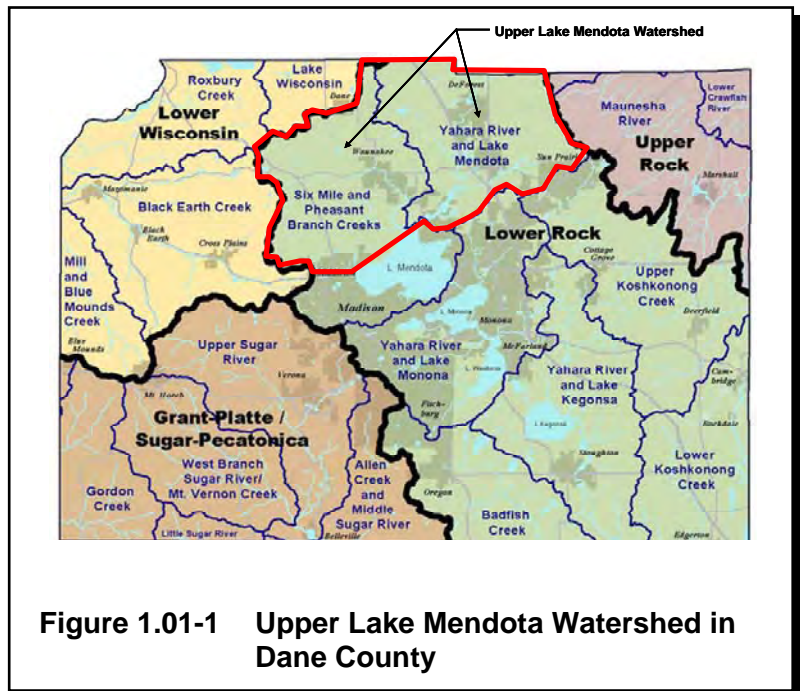

Figure 1.01-1 Upper Lake Mendota Watershed in Dane County

In 2006, the Dane County Board resolved to commission a feasibility study of a County community manure handling facility (Resolution 115, Sub 2). In addition to the water quality issues noted above, the Board’s goals are to study management alternatives that:

- Are financially feasible.
- Reduce odors.
- Reduce greenhouse gases.
- Are environmentally acceptable.
- Reduce BOD, COD, and ammonia in runoff to mitigate the potential for fish kills.

- Provide alternatives to storing manure on the farm for expanding livestock farms, both large and small.
- Lower the cost of operation for Dane County livestock producers.

The County's list of goals also includes providing a place for manure at times of the year when field and weather conditions increase the risk of manure runoff into surface waters. Another goal is to refine manure so that the nutrients are separated and in a condensed form that could allow farmers to use the nutrients required and excess nutrients could be transported or sold out of the area.

There are numerous issues related to individual or community manure management systems. The issues deemed most important to the County's committee include but are not limited to:

- Biosecurity.
- Animal disease.
- Road and transportation issues.
- Green space and urban sprawl.
- End-markets for manure management products including energy, financing methods, management, and business structure.
- Cost and ease of operation.
- Ability of the system to accept industrial wastes or other substrates.
- Overall costs compared to current methods of management.

The scope of this feasibility study included the following tasks and elements:

1. Survey farmers and their current and expected future manure management practices.
2. Select farms to use in the analysis.
3. Select alternatives to be studied, including the following at a minimum:
 - Community anaerobic digester with biogas utilization.
 - Community combustion system with heat and energy recovery.
 - Solids separation and recovery for both a community system and at individual farms.
 - Phosphorus removal and recovery for both a community system and at individual farms.
4. Perform a technical and economic analysis of the short-listed alternatives (up to eight).
5. Perform a nonmonetary evaluation of alternatives to consider issues such as reliability, flexibility, constructability, ease of operation, and environmental soundness.
6. Describe potential financing methods for the recommended project(s).
7. Describe and discuss potential business structures for the recommended project(s).
8. Prepare a draft report for County review, address comments, and prepare a final report.

1.02 ABBREVIATIONS AND ACRONYMS

The following definitions and abbreviations are provided as an aide to the reader:

A. Definitions

Aerobic digestion–Microbial decomposition in the presence of oxygen.

Anaerobic digestion–Microbial decomposition in the absence of oxygen.

Anoxic–A condition in which dissolved oxygen is not available and other forms of oxygen, such as NO₃-oxygen SO₄- oxygen, are used by microorganisms.

Biochemical oxygen demand–Measurement of the oxygen utilized by microorganisms in the stabilization of organic matter.

Denitrification–Anoxic conversion of nitrate to nitrogen gas.

Honey Wagon–Tanker-spreader used to transport and apply liquid waste. In this report, manure is being transported.

Mesophilic–Occurring at a temperature of approximately 95°F (35°C).

Nitrification–Aerobic conversion of ammonia to nitrate by microorganisms.

Population Equivalent (PE)–A term used to compare nonresidential wastewater flows and loads (i.e., commercial, industrial, institutional) to the number of people that would generate an equivalent amount of wastewater. Generally, flow is used to determine PE at a residential equivalent flow of 100 gallons per day. Thus, 1,000 gallons of commercial or industrial flow would represent a PE of 10.

Sludge–Concentrated organic solids produced during wastewater treatment (also termed “biosolids” when secondary sludge is included).

Suspended solids–Particulate matter suspended in wastewater.

Thermophilic– Occurring at a temperature of approximately 131°F (55°C).

Volatile solids–Portion of the solids that is destroyed at temperatures above 550°C and is an indicator of the organic fraction of the total solids.

Volatile suspended solids–Portion of the suspended solids that is destroyed at temperatures above 550°C and is an indicator of the organic fraction of the suspended solids.

B. Abbreviations

A.U.	-	Animal unit(s)
avg	-	average
BOD	-	five-day biochemical oxygen demand
BPR	-	biological phosphorus removal
BTU	-	British thermal units
CBOD	-	five-day carbonaceous biochemical oxygen demand
cfm	-	cubic feet per minute
cfs	-	cubic feet per second
col/100 mL	-	colonies (bacteria) per 100 milliliters
CPR	-	chemical phosphorus removal
DNR	-	Wisconsin Department of Natural Resources
DO	-	dissolved oxygen
EPA	-	U.S. Environmental Protection Agency
ft	-	feet
ft ²	-	square feet
ft ³	-	cubic feet
gpd	-	gallons per day
gpm	-	gallons per minute
hp	-	horsepower
HRT	-	hydraulic retention time
in	-	inches
K	-	potassium
KWH	-	kilowatt-hours
lbs	-	pounds
max	-	maximum
mil gal	-	million gallons
mgd	-	million gallons per day
mg/L	-	milligrams per liter (parts per million in dilute solutions)
MGE	-	Madison Gas and Electric
min	-	minimum
MMBTU	-	million British thermal units
mo	-	month(s)
N	-	nitrogen
NH ₃ N	-	ammonia nitrogen
NO ₂ N	-	nitrite nitrogen
NO ₃ N	-	nitrate nitrogen
NRCS	-	Natural Resources Conservation Service
P	-	phosphorus
ppd	-	pounds per day (or lb/day)
PS	-	pumping station
SBR	-	sequencing batch reactor
TKN	-	total Kjeldahl nitrogen
TN	-	total nitrogen

TP	-	total phosphorus
TSS	-	total suspended solids (or SS)
USDA	-	United States Department of Agriculture
USGS	-	United States Geological Survey
UV	-	ultraviolet
VS	-	volatile solids
VSS	-	volatile suspended solids
WPDES	-	Wisconsin Pollutant Discharge Elimination System
WWTP	-	wastewater treatment plant

SECTION 2
CLUSTER IDENTIFICATION AND SURVEY RESULTS

2.01 CLUSTER IDENTIFICATION

In April 2007, a questionnaire was developed and sent to 117 Dane County farmers in the Upper Lake Mendota watershed to request information related to the farmers’ operations and manure management practices. The questionnaire and cover letter are included as Appendix A. Forty-two farmers responded, including four from anonymous farms, and one survey was returned blank. Therefore, the dataset included forty-one farms. Besides providing data on current and expected future practices, the data was used to form and select clusters for model analyses of manure management systems.

Based on the data analysis, eight potential clusters were identified by comparing location, level of interest, and reported maximum hauling distance. These factors are discussed in Section 2.02. The potential clusters are shown in Figure 2.01-1. From these potential clusters, Clusters 2 and 6 were selected to be included in the study as shown in Figure 2.01-2. These clusters offer large numbers of livestock in two distinct situations. One of the clusters has three farms while the other includes seven, plus one of the clusters includes farms in proximity to each other while the other is more spread out. Cluster 2 is hereinafter referred to as the Waunakee Cluster and Cluster 6 is referred to as the Middleton Cluster. Table 2.01-1 provides relevant statistics for the two clusters.

	Waunakee Cluster	Middleton Cluster
Total Number of A.U.s	3,145	3,813
Dairy Milking Cows	1,590	1,700
Dairy Dry Cows	220	260
Other Adult Dairy	160	370
Adult Beef	100	80
Adult Swine	100	50
Young Stock	730	1,405
Total Poultry	100	0
Average Manure Production (dry lbs/day/A.U.)	10	6
Liquid Manure Production (MG/yr)	23.8	12.77
Solid Manure Production (dry tons/yr)	1,100	3,100
Total acreage for crops	2,150	6,409
Total acreage for manure (leased/owned)	3,620 (2,190/1,430)	4,955 (2,261/2,694)

Table 2.01-1 Cluster Statistics

Legend

- ★ Yes, I am interested in individual farm solutions to nutrient and manure management.
- Yes, but I would like to get more information about the study first.
- Yes, I am interested in potential "farm clusters" or community solutions for farmers.
- ✕ Other respondents.

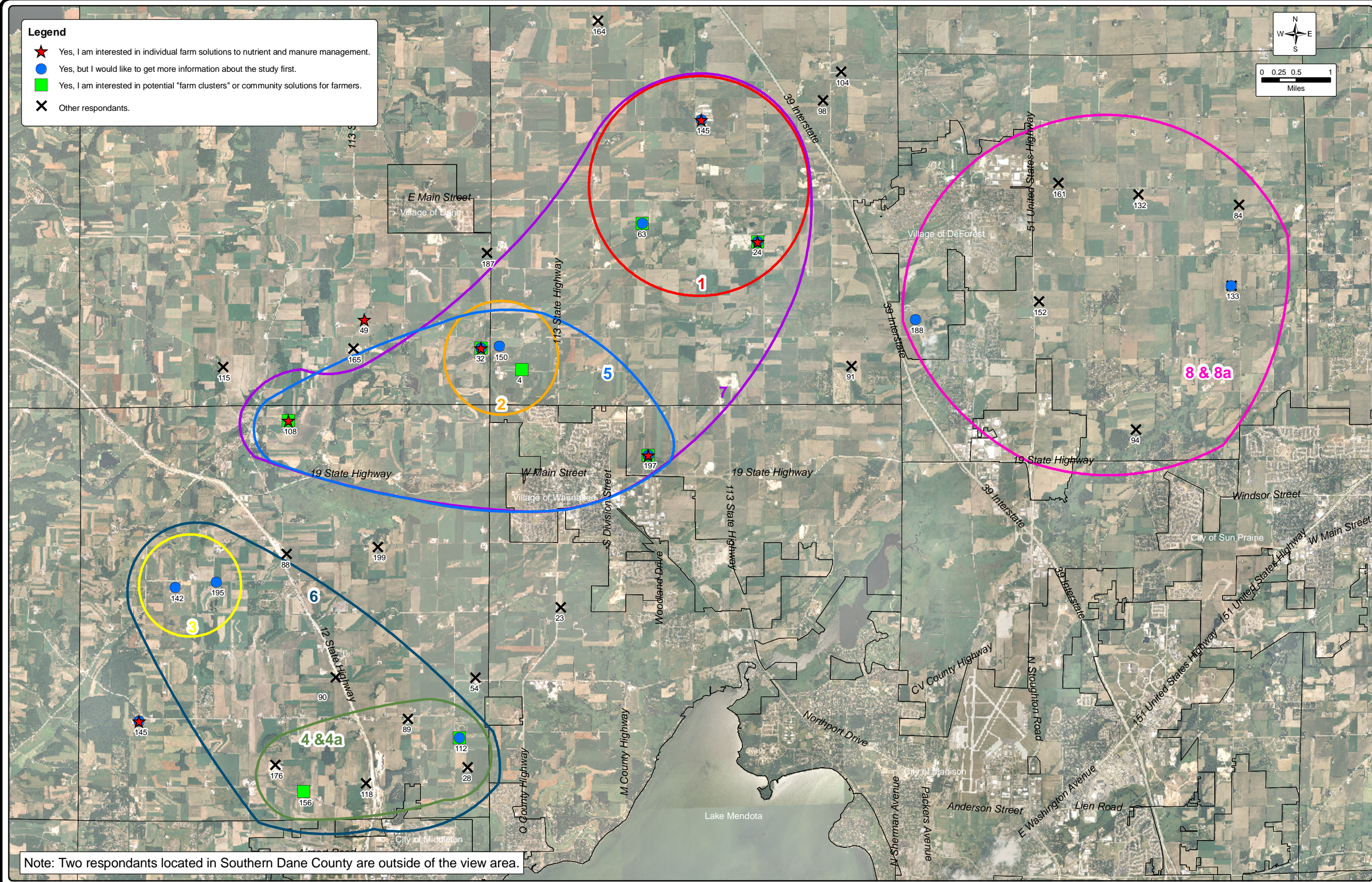

Note: Two respondents located in Southern Dane County are outside of the view area.

**DANE COUNTY MANURE MANAGEMENT SURVEY
POTENTIAL CLUSTER MEMBERS
COMMUNITY MANURE MANAGEMENT FEASIBILITY STUDY
DANE COUNTY, WISCONSIN**



**FIGURE 2.01-1
1-124.005**

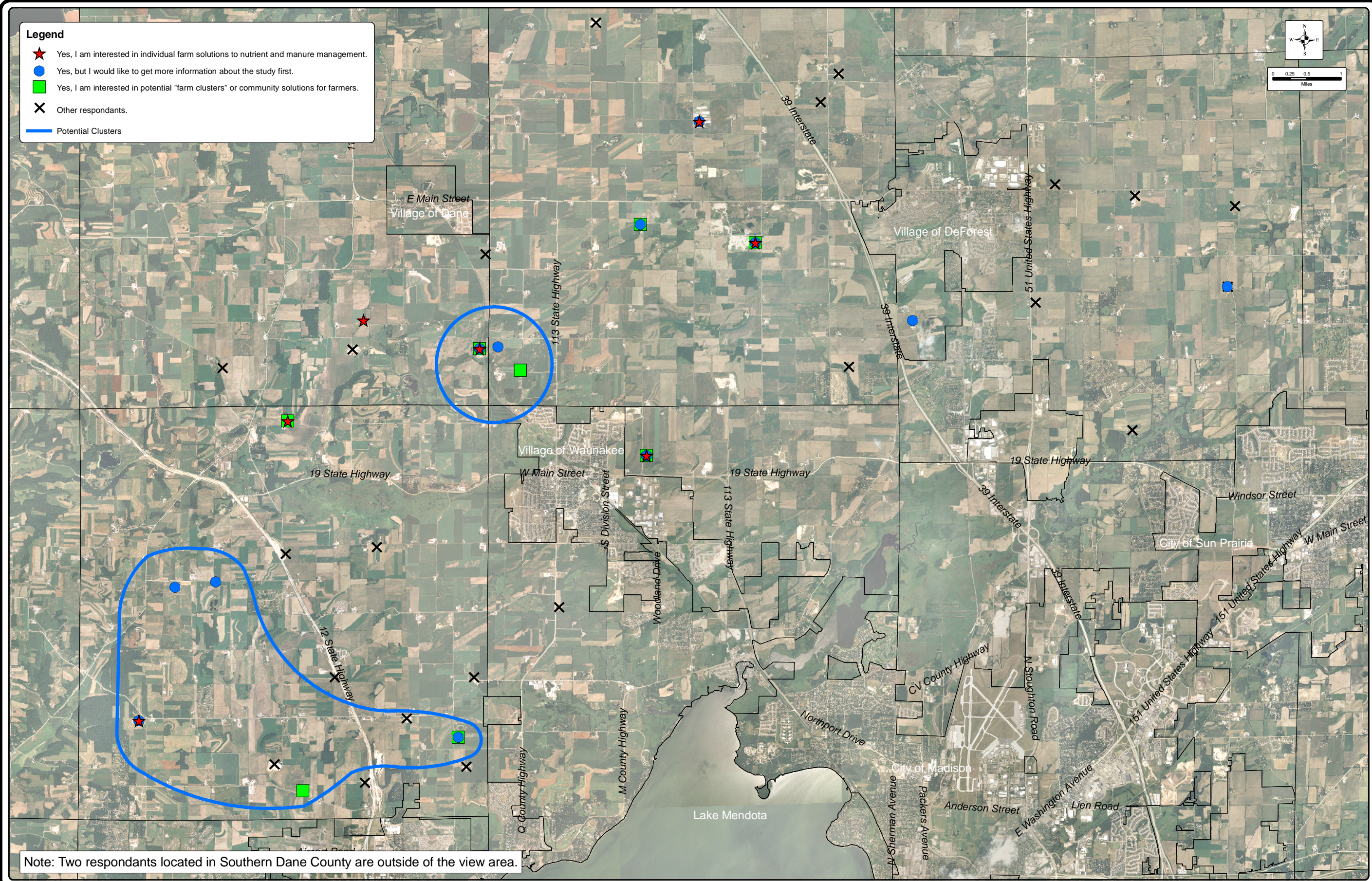

**SURVEY RESPONDENTS IN THE UPPER
 MENDOTA WATERSHED**
**ADDRESSING NONPOINT NUTRIENT LOADINGS THROUGH
 COMMUNITY MANURE MANAGEMENT - A FEASIBILITY STUDY IN
 DANE COUNTY, WISCONSIN**



FIGURE 2.01-2
1-124.005

A. Waunakee Cluster

The Waunakee Cluster, which is located northwest of Waunakee between Highway 113 and the Wisconsin and Southern Railroad near Maier Road, includes farm numbers 4, 32, and 150. These three farms have a current total of approximately 3,145 animal units. In 2012 they expect to have 3,437 animal units. They are neighboring farms in proximity to each other. The maximum manure hauling distance these three farms reported is 13, 5.5, and 10 miles, respectively. A community manure management system located in this cluster should significantly decrease the transportation burden for the farms. They annually spread approximately 23.8-million gallons of liquid manure and 1,100 tons of solid manure on 3,620 acres of land. Manure-collecting procedures at the farms involves scraping or pushing manure into a pile, scraping or pushing manure into pits or tanks, and flushing or pumping manure into pits or tanks. All three farms use multiple systems depending on barn configurations and bedding materials. Farms estimated between 1.5 and 4 hours per cow per year (average 2.9 hours per cow per year) of labor spent on manure-related activities including collecting, storing, hauling, applying, and administration. Animal bedding type, volume, and cost varied widely between the farms. Sand, straw, corn stalks/soybean stubble, rice hulls, and sawdust/wood chips are all used for bedding. Sand and sawdust are the two most widely used materials for bedding in this cluster.

B. Middleton Cluster

The Middleton Cluster is located northwest of downtown Middleton. The majority of the seven farms are in the area between County Highway P, County Highway K, Pheasant Branch Road, and Airport Road. The remaining farms are located between County Highway P and Highway 12 north of County Highway K. The cluster includes farm numbers 89, 112, 142, 145, 156, 176, and 195. These farms have a current total of 3,813 animal units. In 2012 they expect to have 3,967 animal units. The maximum hauling distance these farms reported is between 1 and 8 miles. They currently spread approximately 12.77 million gallons of liquid manure and 3,100 tons of solid manure on 4,955 acres of land. Manure-collecting procedures at the farms involves scraping or pushing manure into a pile, scraping or pushing manure into pits or tanks, and flushing or pumping manure into pits or tanks. Most of the farms use multiple systems depending on barn configurations and bedding materials. Farms estimated between 1.5 and 3 hours per cow per year (average 2.5 hours per cow per year) of labor spent on manure-related activities including collecting, storing, hauling, applying, and administration. Animal bedding type, volume, and cost varied widely between the farms. Sand, straw, corn stalks/soybean stubble, rice hulls, and sawdust/wood chips are used for bedding.

2.02 SURVEY QUESTIONS AND DISCUSSION

In the following subsections, we discuss the responses to the survey questions. Most of the questions were analyzed with respect to the entire survey set; however, some of the questions were analyzed with respect to the two selected clusters when the data were more meaningful on a cluster basis.

A. Question 1—Greatest Farming Challenges

Figure 2.02-1 shows the percent of respondents who indicated they were concerned about the listed issues now versus the future. In all cases, the respondents indicated that future challenges are a greater concern than current challenges. Two of the categories show significant increases in level of concern between current and future conditions. While currently of relatively low concern at about 40 percent of respondents, disposal of livestock manure and environmental laws and restrictions show an increase to the highest concerns in the future with 70 to 80 percent of respondents indicating that these issues will likely be their greatest farming challenges.

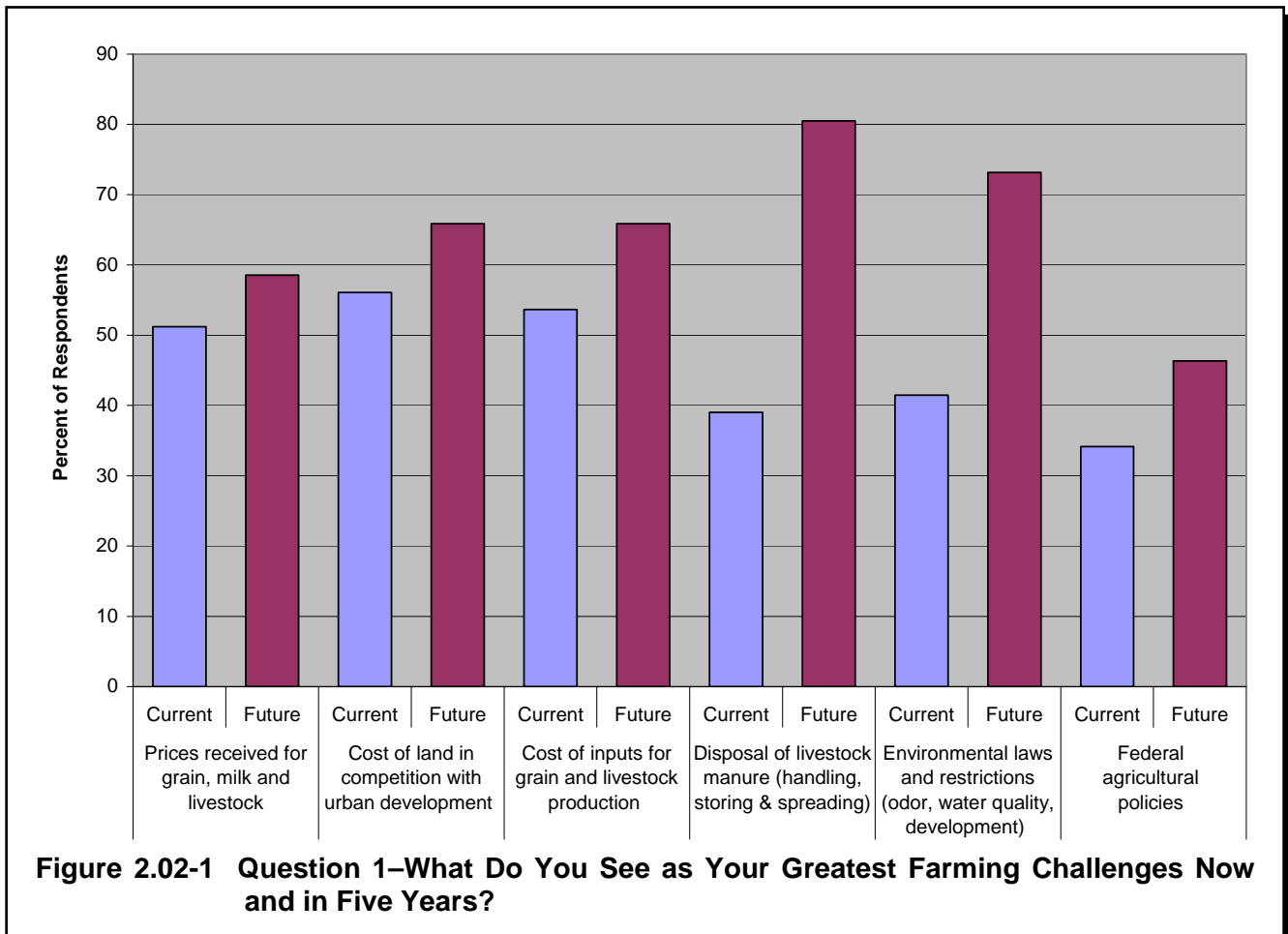

B. Question 2—Acreages and Cropping Practices

Respondents crop an average of 680 acres, and they are applying manure on an average of 420 acres (includes land owned by farmer and owned by others) per farm. Most of the land used for manure application is planted in corn. The only other crop categories that had mentionable manure applications were alfalfa, clover, and other forage crops. All other crop land (soybeans, small grains, vegetables, and pasture) is relatively limited in its use for manure application according to respondents.

Respondents crop a total of approximately 21,000 acres of land in Dane County that they own or rent. They spread manure on 8,650 acres that they own and an additional 9,400 acres of rented land. During follow-up discussions, many of the farmers commented that they give manure away to neighbors because they do not have enough land nearby on which to spread manure. Oftentimes it is more cost-effective to give manure away and purchase fertilizer for land far away from the farm than to truck manure to the land.

C. Question 3—Number of Animals

Respondents currently have 19,821 head animal units (A.U.) of livestock and poultry, including the types shown in Figure 2.02-2. Nearly one-half (49 percent) are milking cows, dry cows, and other adult dairy animals. Additional dairy animals, such as calves and replacement heifers, are included in the young stock (33 percent) group. The remaining 18 percent includes adult beef (9 percent), adult swine (4 percent), bulls (4 percent), and poultry (1 percent). The total A.U.s. expected to increase by about 9 percent between 2007 and 2012.

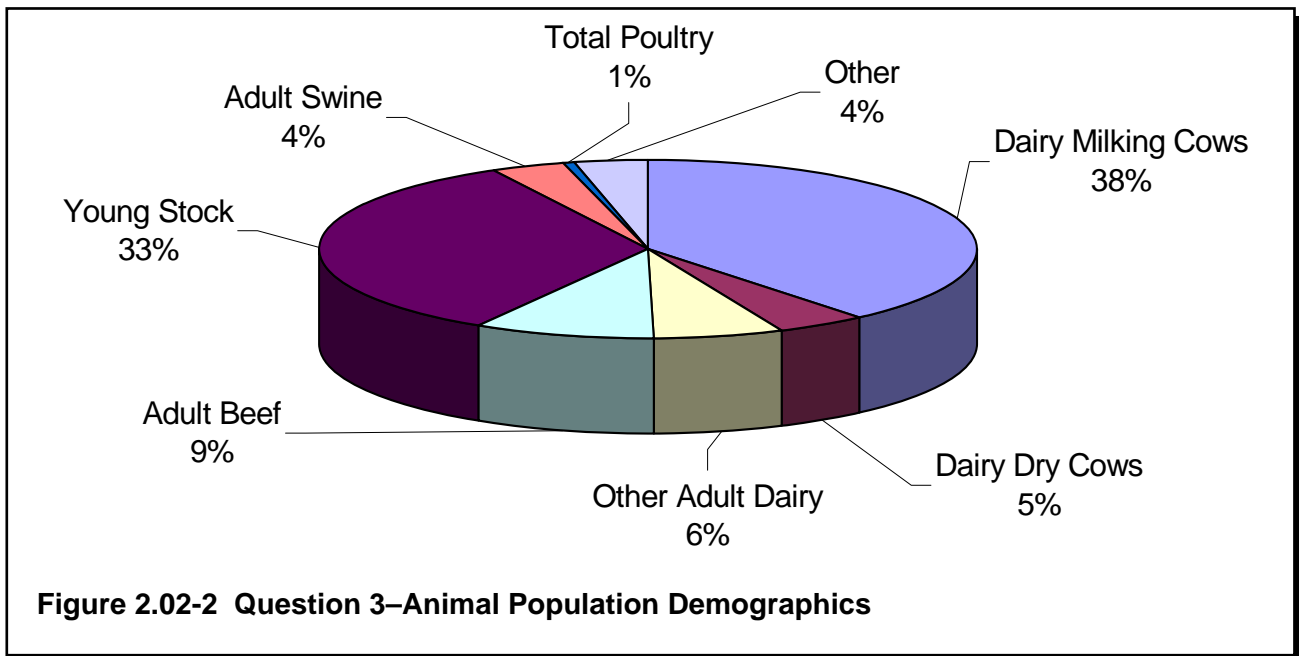

D. Question 4—Manure Production

Manure production was evaluated on a cluster basis. Survey respondents reported the amount of liquid manure generated in gallons per year and the amount of solid manure generated in tons per year. In order to compare and analyze overall manure production, reported liquid and solid manure was evaluated on a dry matter basis. Manure quantities and masses were converted to dry pounds per day (lbs/d) for liquid and solid manure. Liquid manure was assumed to be 6 percent dry matter, and solid manure was assumed to be 24 percent dry matter based on typical numbers reported in the *Nutrient Application Guidelines for Field, Vegetable, and Fruit Crops in Wisconsin* published by the UW Extension. The total amount of manure for each cluster was divided by the number of equivalent A.U.s. in that cluster to develop manure loadings in dry lbs/d/A.U. The

Middleton cluster produces approximately 6.4 dry lbs/d/A.U., while the Waunakee cluster produces approximately 9.7 dry lbs/d/A.U. The *Nutrient Management Fast Facts* brochure published by the Nutrient and Pest Management Center at University of Wisconsin reports manure output as being 148 lbs/d (wet weight) for dairy cows. When this number is converted to dry lbs/d/A.U. (assuming 6 percent solids and 1.4 A.U. per dairy cow), the result is 6.3 dry lbs/d/A.U. Since the literature value matches one of the two cluster values, the literature value will be used for future calculations.

E. Question 5–Manure Collection

The results of Question 5 are shown in Figure 2.02-3. Forty-three percent of respondents only scrape or push solid manure into a pile. Twenty-six percent only scrape or push liquid manure into a pit or tank, and 30 percent use a combination of these methods. Only 15 percent of respondents flush or pump manure, and all respondents who flush or pump manure concurrently utilize another method of manure collection on the farm.

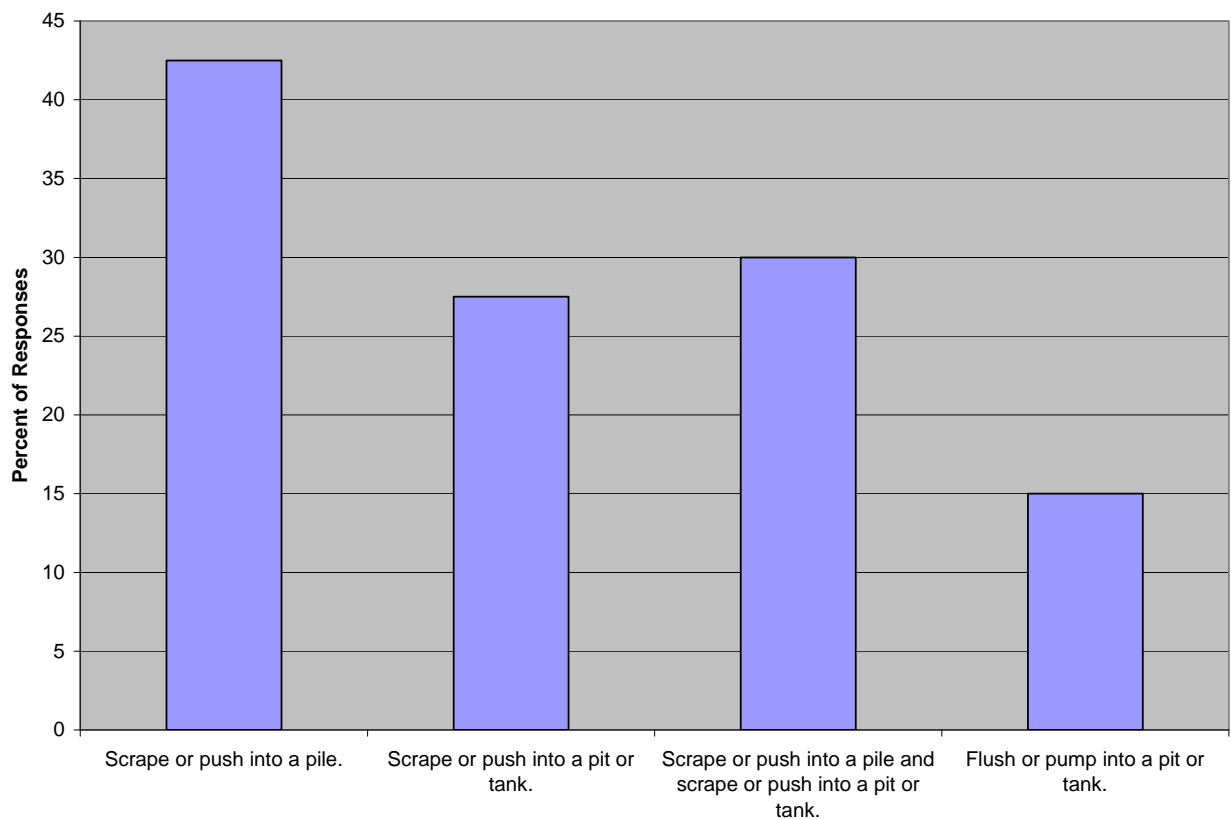

Figure 2.02-3 Question 5–What is Your Current Method of Manure Collection?

F. Question 6—Manure Storage

Farms use many configurations for manure storage ranging from a simple unlined lagoon that is gravity fed from the barns to pumped, multiple-stage systems. Unlined lagoons, lined lagoons, slurry tanks, and concrete wall pits are used for liquid storage. Farms that do not have storage units usually store manure in a spreader and frequently haul it to fields. However, Dane County regulations restrict manure spreading. Of particular concern are the restrictions on the spreading of liquid manure on frozen, snow-covered, or ice-covered ground in certain areas (e.g., near water ways), on sloped land (e.g., prohibited on slopes greater than 12 percent), and without effective incorporation (unless approved by the County). For this reason, it is important that farms have enough storage to store manure while the ground is frozen.

Storage at the cluster farms was evaluated based on the theoretical volume needed to store six months of 6 percent liquid manure for the equivalent animal units at the farm. Seven of the ten farms appear to have adequate storage for these conditions at the current and future animal populations. Overall, each cluster has enough storage for liquid manure.

G. Question 7—Manure Application

The manure application methods are shown in Figure 2.02-4. The majority of farms use a manure spreader for manure application. Another popular method includes use of a honey wagon. Twenty percent of respondents incorporate manure into the soils within 72 hours of application.

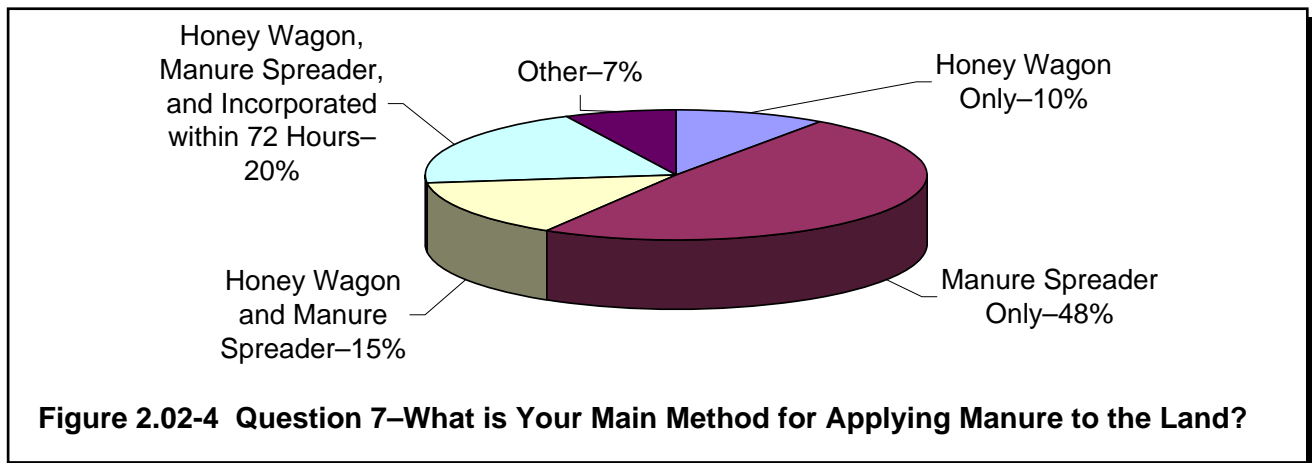

H. Question 8—Manure Hauling

Respondents reported hauling manure between zero and 15 miles. Nearly 30 percent of farms haul 1 mile or less, and approximately 85 percent haul 5 miles or less. All farms that have more than 700 A.U.s. haul more than 2.5 miles, while all farms that have more than 1,000 A.U.s. haul more than 5 miles. Figure 2.02-5 depicts the number and size of farms that haul within each range. It generally shows that as the number of A.U.s. increases, so does the likelihood of having increased hauling distances.

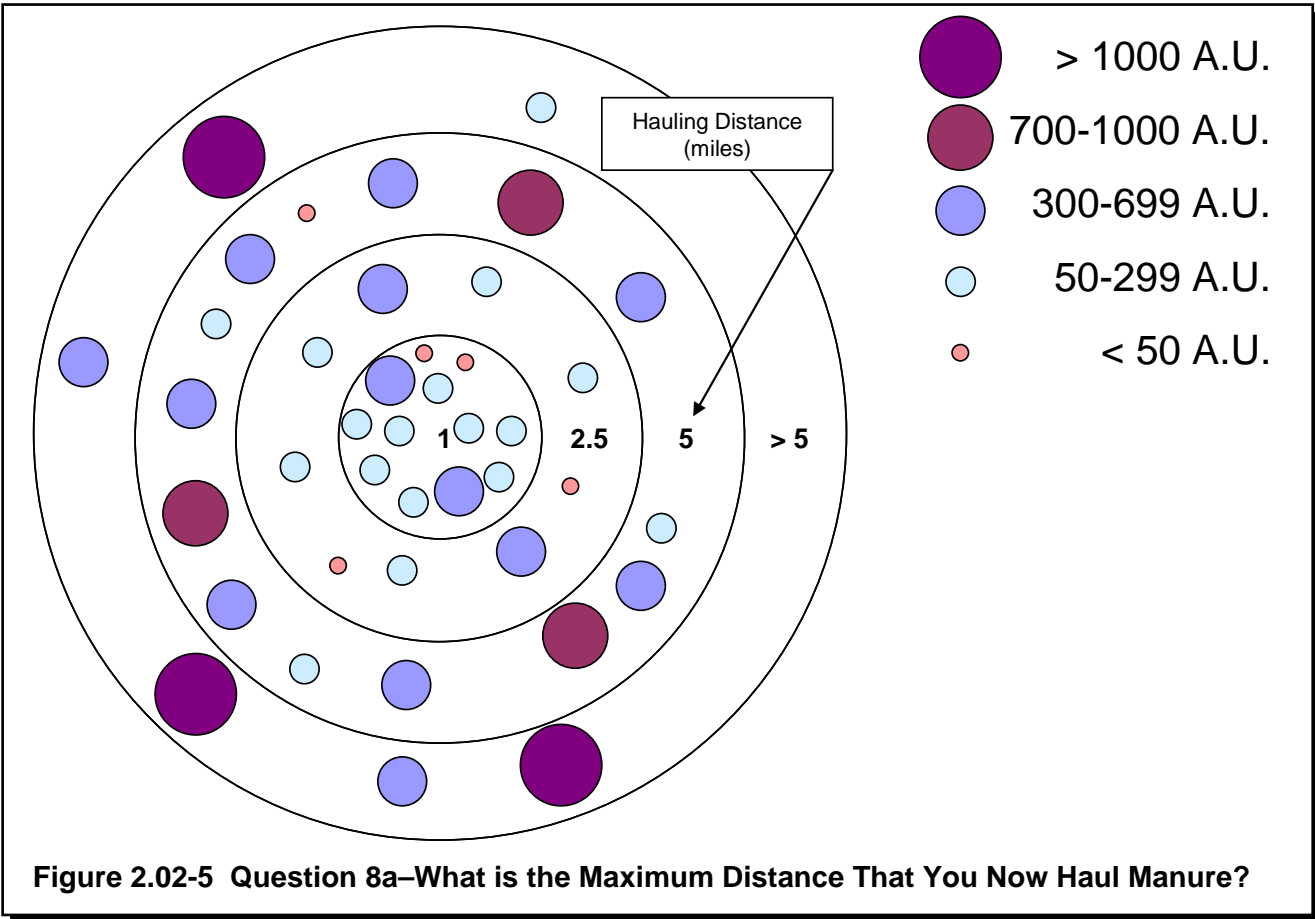

When asked if they would be willing to increase the maximum hauling distance if a manure processing station were available, farmers gave mixed responses. As depicted in Figure 2.02-6, nearly one-half of respondents had negative responses, one-third were not sure, and one-fifth had positive responses. Considering the unlikely chance that farmers would increase hauling distance, clusters were selected to fall within reported hauling distances for each farm.

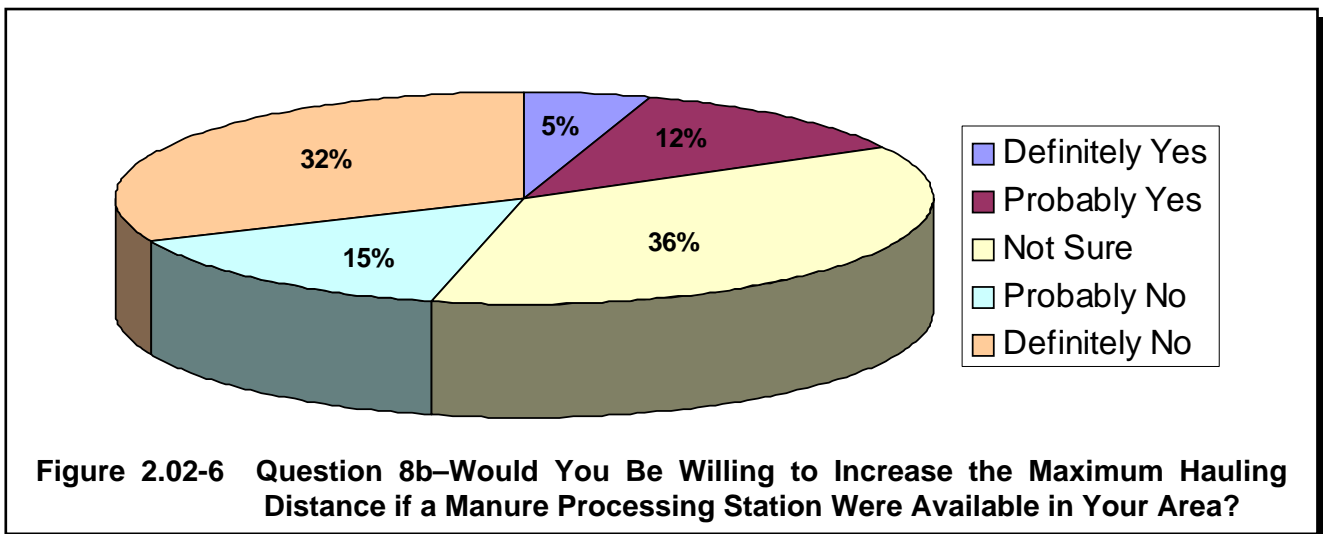

I. Question 9—Animal Bedding Materials

Respondents use a wide variety of bedding materials including sand, straw, corn stalks/soybean stubble, sawdust/wood chips, oat hulls, and rice hulls. Corn stalks/soybean stubble (73 percent) had the highest frequency of use, followed by 51 percent of respondents using straw (51 percent) and sand (37 percent). Most farms use two types of bedding.

Farms in the Waunakee Cluster use sand, straw, corn stalks, sawdust, and rice hulls for bedding. Typically a farm will use one material for a majority of the bedding, referred to here as primary bedding, with other materials used for specific groups of animals. Two of the farms in this cluster use sand as their primary bedding and the other uses sawdust. They prefer sand and sawdust because they believe the level of cow comfort and disease control is increased with these materials. This cluster spends approximately \$50,000 total a year on bedding purchased from others with 75 percent of this cost being spent at one farm.

Farms in the Middleton cluster use sand, straw, corn, sawdust, rice hulls, and oat hulls for bedding. Primary bedding preference for the seven farms is split among using sawdust (2), sand (2), corn stalks (1), oat hulls (1), and rice hulls (1). This cluster spends about \$90,000 total per year on bedding purchased from others, with 75 percent of the cost being spent at two farms.

J. Question 10—Cost of Water Used on Farm

Sixteen of the 41 respondents reported an annual water usage amount, and 16 reported annual electricity cost for pumping water expenses. Only 8 of the 41 respondents reported both water usage and electricity cost for pumping. The reported water usage was generally highest for farms with flushing systems, followed by farms with liquid manure. Farms with solid manure generally used the least amount of water. There were not enough data to generate any correlations between A.U. and water usage or water pumping expense. Further investigation into this issue would be necessary to develop defensible numbers that are specific to the survey respondents. Textbook data will be used for water usage rates and costs in subsequent study evaluations.

K. Question 11—Time Spent on Manure Management

Overall, the amount of time reported for manure management in each cluster is proportional to the number of A.U.s. within each cluster. The Waunakee cluster reported spending just over 9,000 total hours per year on manure management activities for 3,145 A.U. or about 2.9 hours per A.U. per year. The Middleton cluster reported spending closer to 9,500 total hours per year for 3,813 A.U. or about 2.5 hours per A.U. per year. The majority of manure management time is spent collecting, hauling, and applying manure. Figure 2.02-7 shows the breakdown of manure management time for each cluster.

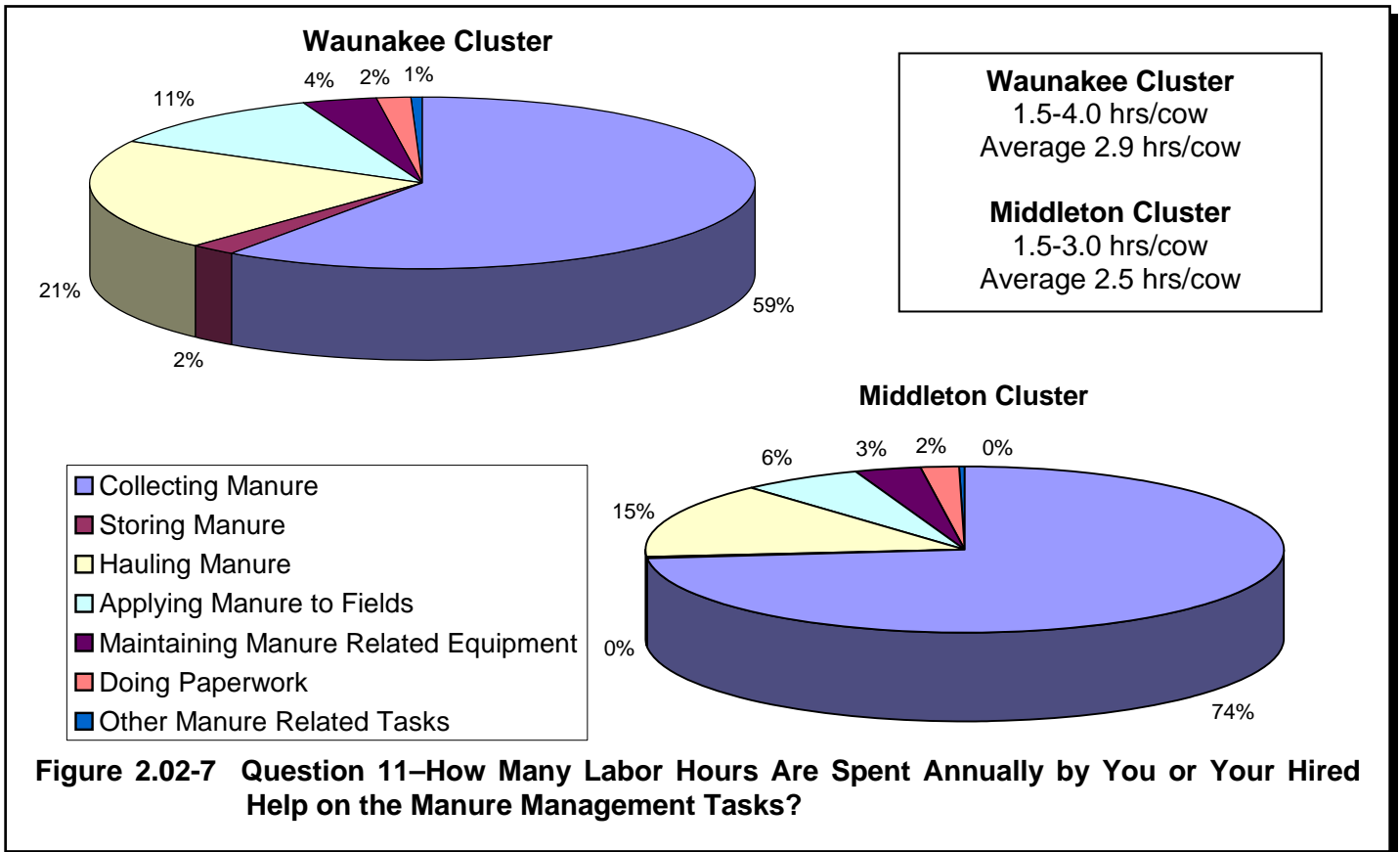

L. Question 12–Nutrient Management Plans

Eighty-two percent of survey respondents have a nutrient management plan. Eighty-six percent of respondents believe they have enough land to meet phosphorus-based land application limitations. There were insufficient data to determine the additional land needed by those who do not believe they have enough land for phosphorus-based land application limitations. Nearly a third of farmers believe that manure disposal requirements are limiting farm expansion.

M. Question 13–Level of Concern

Figure 2.02-8 shows the distribution of responses for degree of concern related to five aspects of manure management. The mean rating scores on the scale where 1=Not At All Concerned and 5=Very Concerned were high for manure spreading regulations (4.32), local water quality (4.17), hauling on highways (3.98), residential development (3.93), and odor or bad smells (3.80). Roughly one-half are Very Concerned about local water quality (51 percent) and manure spreading regulations (46 percent).

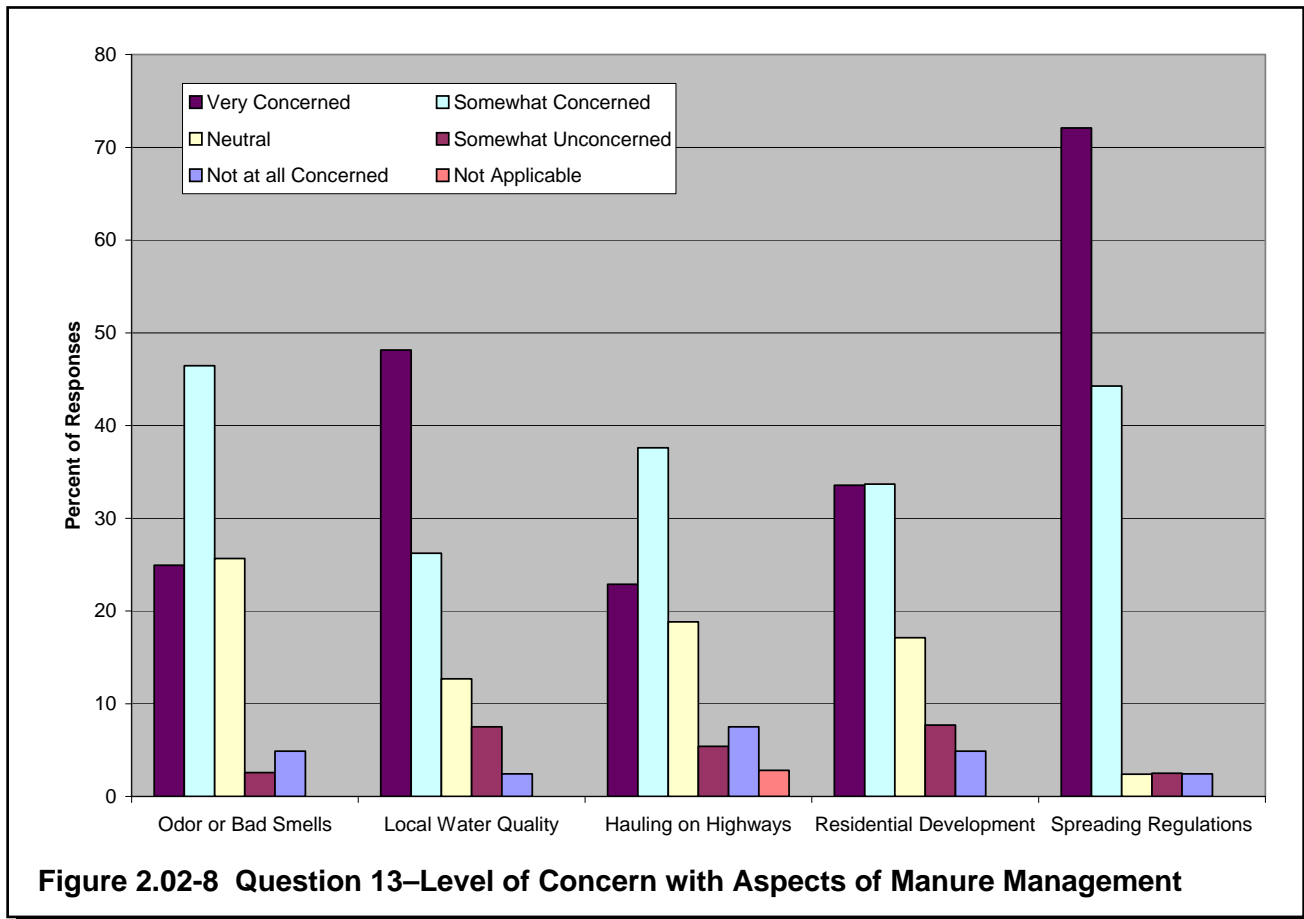

N. Question 14–Future Farming

This question related to the farmers’ plans for continuing – farming operations in the future. A majority of respondents plan on staying in the farming business well into the future. Of the 78 percent that plan to continue operating the place as a farm, 27 percent plan on expanding, 31 percent plan on staying the same size, and 20 percent plan on decreasing size over the next five years. Size was defined as the total number of A.U. at the farm. Twenty-two percent of respondents indicated they personally may not or will not continue farming, although family members might continue to operate the farm.

O. Question 15–Potential Obstacles

When asked what obstacles would need to be overcome before farmers would accept a community manure processor that served many livestock operations, these three themes were repeated many times: location, cost, and hauling/transportation logistics. Thirty-three respondents chose to provide answers to this open-ended question. Seventy percent of the written responses mentioned location, 58 percent mentioned cost, and 52 percent mentioned hauling or transportation logistics. Other responses that were repeated multiple times included protection from diseases or biosecurity and the value of the nutrients or organic matter in the manure. Other

concerns mentioned were time, odor, noise, sand and foot bath chemical compatibility, facility operation, and convenience. We recommend a careful review of the verbatim answers.

P. Question 16-Interest in Participating in the Study

Figure 2.02-9 is a geographic representation of the survey respondents and their level of interest. These data along with animal populations, future business plans, and reported maximum hauling distance were used to develop potential clusters. Locations with farms in proximity which responded: “Yes, I am interested in potential ‘farm clusters’ or community solutions for farmers.” or “Yes, but I would like to get more information about the study first.” in proximity were thought to be the best candidates for a farm cluster.

Legend

- ★ Yes, I am interested in individual farm solutions to nutrient and manure management.
- Yes, but I would like to get more information about the study first.
- Yes, I am interested in potential "farm clusters" or community solutions for farmers.
- ✕ Other respondents.

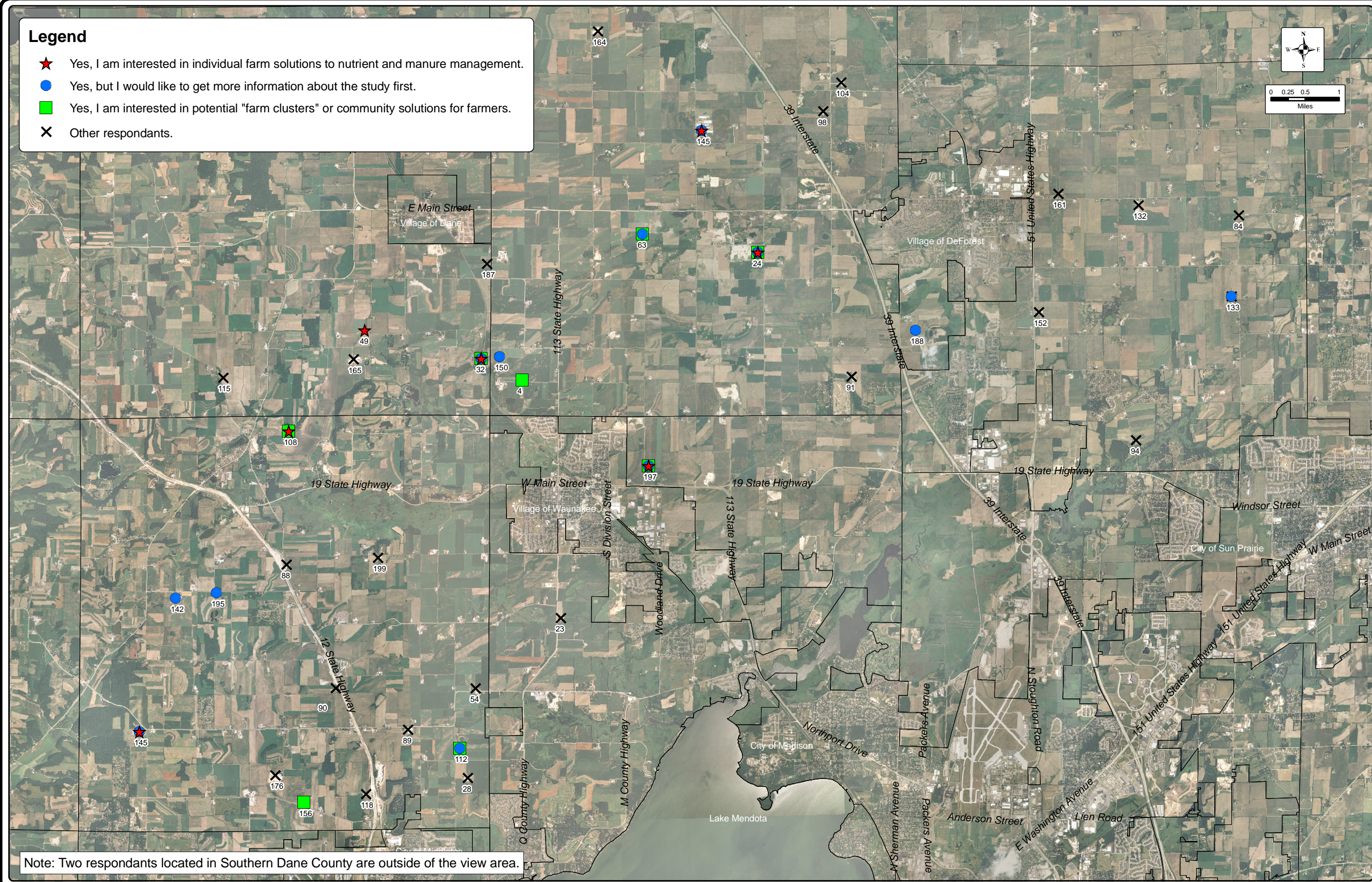
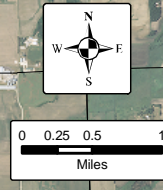

DANE COUNTY MANURE MANAGEMENT SURVEY
QUESTION 16 - RESPONDENTS AND INTEREST LEVEL
COMMUNITY MANURE MANAGEMENT FEASIBILITY STUDY
DANE COUNTY, WISCONSIN



FIGURE 2.02-9
1-124.005

SECTION 3
TECHNOLOGY REVIEW AND SHORT LIST

3.01 LITERATURE REVIEW AND FARM VISIT SUMMARY

This study included a limited literature review to evaluate the status of various manure management technologies. It also included visits to approximately ten Dane County farms, including the cluster farms identified in Section 2 and others nearby. The review and visits focused on viable technologies for manure solids destruction and stabilization, manure solids separation, and phosphorus removal and recovery from manure. Also, several articles in the reviewed literature related to benefits of manure management technologies, such as energy generation and byproduct solids reuse. A brief summary of this literature review, including the current state of the technology for manure management, is included herein.

There is considerable interest in manure management technologies throughout the world. New technologies and methods for managing manure are under development, and significant research is being conducted on manure management at numerous universities and corporations. The literature review included is not intended to be all-encompassing but rather a summary of a range of technologies that may be viable at the current time.

A. Biological Manure Treatment

Manure stabilization is achieved through processes that further decompose the manure, which results in a waste stream that has fewer solids and, depending on the method, has reduced pathogen content. Technologies that have been used for manure stabilization include anaerobic digestion, aerobic digestion, and composting. These technologies are described in the following paragraphs.

1. Anaerobic Digestion

Anaerobic digestion (AD) involves biological decomposition of organic matter in the absence of oxygen. Several groups of facultative and strictly anaerobic bacteria convert complex manure solids into stabilized solids, methane, carbon dioxide, and water. AD is likely the most commonly used “innovative” manure management technology employed at farms today. In Wisconsin alone, there are more than 20 anaerobic digesters in use, with many more in the planning stages. In addition, AD has been used for decades to stabilize municipal wastewater solids and to treat industrial wastes.

AD systems come in a variety of forms, including:

- Covered lagoon
- Plug flow
- Complete mix
- Temperature-phased AD (TPAD)
- Slurry loop
- Anaerobic sequencing batch reactor
- Fixed, thin, or mobilized film
- Attached media
- Two-stage digester
- Floating bed

AD is also classified by operating temperature, the most common being mesophilic (86°F to 104°F) and thermophilic (120°F to 140°F). TPAD uses thermophilic digestion followed by mesophilic, and this process achieves a higher level of pathogen and volatile solids destruction in a shorter period of time compared to mesophilic alone.

Solids separation can be used upstream or downstream of AD. If used upstream, manure fibers can be removed prior to AD and used for bedding or other purposes. Removal of solids upstream as opposed to downstream may remove more TP and total nitrogen from the system because these compounds tend to become soluble during digestion. In addition, the digester will be less prone to solids accumulation if solids separation is employed upstream of AD. Solids separated after anaerobic digestion can be used for livestock bedding or compost. The liquid portion is typically land-applied on farm land. Methane (“biogas”) can be used to generate heat for the digester and nearby buildings or can be used to produce electricity using engine generators, microturbines, or similar equipment.

By itself, AD does not significantly change the total mass of nutrients (N, P, and K) in the manure, although it does change the form of some nutrients. For example, organic nitrogen is converted to ammonia-nitrogen. The benefits of AD include a reduced mass of solids requiring ultimate disposal, the generation of biogas (renewable energy potential), odor reduction, the reduction of pathogens in the digested manure, and a relatively low energy requirement for the process. The drawbacks of AD include its relatively high construction cost and complexity compared to typical farm operations. Some AD systems do not produce methane in excess of that needed to heat the AD system.

2. Aerobic Digestion

AD systems require the addition of air for mixing and to provide oxygen for the decomposition of organic matter. These systems do not produce biogas. Byproducts include stabilized solids, water, and carbon dioxide. As with anaerobic systems, several forms are available, including:

- Aerated lagoons.
- Suspended growth.
- Autothermal thermophilic aerobic digestion (ATAD).

It is not known if any of these systems are in operation for manure stabilization in Wisconsin or elsewhere, although there are many systems in use for municipal and industrial sludge digestion. Aerobic digestion involves a high level of energy input for aeration and mixing, and the cost of this energy makes it less attractive for farm use. If adequate mixing and aeration are not provided, these systems will normally produce offensive odors. Autothermophilic systems typically require covers and odor control equipment. An advantage of aerobic digestion is that it is simpler to operate than AD as it does not require a biogas utilization system and related safety equipment.

Aerobic digestion does not change the total mass of P and K in the manure. It can be operated to remove some of the N through nitrification and denitrification processes, if desired.

3. Composting

Composting involves combining manure with a bulking agent, such as crop residue, yard wastes, wood chips, or sawdust, in piles, rows, or vessels. The material is periodically mixed or turned to provide the required oxygen for the aerobic degradation. Natural microbes including bacteria and fungi break down the organic material into stabilized solids, carbon dioxide, and moisture. The temperature normally increases to more than 160 degrees F during the process, which destroys pathogens and weed seeds. Composting will not reduce the P content, but it may reduce N content of the manure (through ammonia leaching or denitrification in anoxic portions of the compost). The finished material is a stabilized, organic, soil-like product that is rich in nutrients and can be used on the farm or in landscaping and gardening. The compost can also be screened to improve uniformity and value.

There are three composting sites in or near Madison that are owned by Dane County, as well as two private composting sites owned by the Bruce Company. These sites presently compost yard waste and similar materials. Wisconsin solid waste regulations (Administrative Code Chapter NR 502) do not allow composting of manure or food at these sites unless proper site design is used (for example, using an impervious surface below the composting operations). However, there are at least two manure composting sites in Wisconsin that have received variances from the impervious surface requirements and are required to perform monitoring in lieu of strictly meeting the code. One of these is located near Eau Claire, and the other is near Milwaukee in Washington County and has been operating for approximately 10 years.

The University of Illinois is presently investigating manure composting. Research and Extension programs at the University include evaluating the composting process, compost quality, and compost use in a variety of applications.

A few wastewater treatment plants in Wisconsin are exploring composting or similar processes. As one example, the Madison Metropolitan Sewerage District (MMSD) is piloting a method similar to composting known as "Metro Mix." MMSD intends to produce a low-pathogen content sludge using TPAD. MMSD will then dewater the digested sludge using centrifuges and mix the dewatered sludge with sand and/or sawdust. This mixture, if the pathogen content is low enough, is anticipated to be suitable for residential or nursery use as a gardening or potting soil. Because of the high fiber content of digested cow manure solids, and MMSD's potential difficulty finding inexpensive sawdust, there may be some merit to exploring the use of digested, separated manure solids in lieu of sawdust as an amendment to MMSD's "Metro Mix."

B. Manure Thermal Treatment Processes

Thermal treatment processes have been used for manure stabilization and solids destruction at both the pilot scale and full-scale. Common combustion processes include combustion, pyrolysis, and gasification.

1. Combustion

Combustion involves the burning of solids to significantly reduce their volume. Byproducts include ash, airborne oxides of C, N, and S, and heat. The combustion heat can be used to preheat or dry the feed solids to allow combustion without the need for supplemental fuels such as fuel oil or natural gas. Drying of the manure prior to combustion is required to reduce the amount of water for autothermal combustion. Electricity can be produced by generating steam and using a steam turbine to generate electricity.

A manure combustor has been built in Brown County, Wisconsin, at the Wiese Brothers Farm, with the goals to eliminate manure spreading and generate electricity. It is a proprietary system known as Elimanure[®]. The Elimanure system uses a Bio-Dryer, Combustor, Bio-Steam, and a Turbine Generator to generate electricity from the steam produced in the combustion process. The system started up in late 2005. Manure is dried using waste heat from the combustion prior to feeding the solids to the combustor. The ash from this system is reported to be approximately 2 percent of the mass input. The Wiese Brothers system is currently out of service to replace the combustion chamber.

Combustion facilities have also been built for handling poultry manure. There are also numerous full-scale municipal sludge combustors in the United States, including two in Wisconsin (De Pere and Green Bay).

Bacteria and pharmaceuticals are destroyed in the combustion process. During the drying process, some nitrogen, sulfur, moisture, and carbon dioxide would be emitted to the atmosphere during this process. Nitrogen, sulfur, and carbon dioxide would also be present in the flue gas and could either be captured using air pollution control equipment or released to the atmosphere if the concentrations are below regulatory limits. The combustor ash would contain most of the P, K, calcium, and other minerals that were present in the feed solids and could potentially be used in place of lime as a soil amendment.

The combustion process may be attractive to Dane County farmers because it would condense the P so that it can be exported, possibly as a nutrient source, or landfilled. However, nitrogen would be lost and unavailable for use as a nutrient source. If cost-effective and technically feasible, the process could be combined with a technology that captures the N from the stack emissions so that it can be used as a nutrient source rather than entering the atmosphere as an air pollutant.

It may also be possible to burn a dried, pelletized manure product in home biofuel burners to generate heat or as a supplemental fuel in existing coal-fired power plants to generate electricity. However, there are no existing applications known at this time.

2. Pyrolysis

In the pyrolysis process, heat is used to convert manure into three main products: a solid (char), a liquid fuel, and a gaseous fuel. A system is under development in Wisconsin by financial backers from Cashton who purchased a pyrolysis technology firm in Australia and had the prototype shipped to Wisconsin in late 2005. This system is in the pilot stage only, and no literature could be found related to full-scale installations of this technology in the United States or abroad. The markets for the solid, liquid, and gaseous byproducts of pyrolysis are not well-defined or developed to date. Therefore, developing this technology to a level of comfort needed for this study is not as feasible as with combustion or other technologies.

3. Gasification

Gasification is similar to pyrolysis, but the emphasis is on the production of a gaseous fuel. Gasification of coal was used to produce coal gas before natural gas use became widespread. During World War II and shortly thereafter, some cars in Europe had gasification systems to make a fuel gas out of wood. There is renewed interest in this technology for cars in recent years. The literature indicates that this technology is in the pilot stage for use with cow and swine manure, including a pilot fluidized bed gasification facility at Iowa State University. Swine manure has gone through more testing than cow manure. With swine, the manure needs to be at least 40 percent dry matter prior to gasification to obtain desirable results.

C. Solids Separation and Drying Technologies

1. Sand and Grit Separation

There are several full-scale systems being employed for removal of sand bedding from manure and flushing water. Simple nonmechanical systems included sedimentation in lagoons or long channels to separate sand from manure. The sand particles are much denser than manure solids, and the sand tends to settle out of the liquid/manure stream fairly readily.

More active mechanical systems have been employed for grit removal at industrial and municipal wastewater treatment plants. Some of these are being implemented for sand removal at farms, including vortex grit removal and aerated grit removal. The removed sand can be further concentrated and cleaned using grit washers, grit classifiers, and grit dewatering systems. These systems produce sand suitable for reuse as bedding material.

If sand is not removed from the manure stream, its abrasiveness can damage manure handling equipment and can build up in storage tanks and digesters, reducing the effective volume of these units.

One of the farms involved in this study pilot tested a sand-removal system this year. Many attended the demonstration and results have been received. However, further interpretation from the manufacturer is necessary before reporting. The farm is investigating alternative vendors at last communication.

A sand-removal fact sheet was developed by Dane County and is available on its web page.

2. Manure Solids Separation

Solids separation and recovery can be evaluated as a stand-alone process or part of a larger manure management treatment train. It may be used in either a community system or an individual farm manure management system. Several solids separation technologies are currently in use at farms for concentrating manure solids and recovering fiber for bedding. These technologies may include one or more of the following:

- Gravity settling and thickening in tanks or lagoons.
- Stationary inclined screens.
- Vibrating screens.
- Screw presses.
- Rotary drum thickeners.
- Centrifuge thickening or dewatering.
- Belt, roller, or screw presses.
- Dissolved air flotation thickening.
- Membrane filtration (e.g., ultrafiltration, nanofiltration, reverse osmosis).

Ultrafiltration was pilot-tested by one of the farmers involved in this study and was deemed not feasible for full-scale installation because of cost, ultimate discharge issues, and feasibility.

On at least one Dane County farm, screw press separators are being used to separate solids from flushed manure for reuse as bedding. The liquid stream is discharged to a primary and secondary lagoon system into which proprietary microbes are added and a low amount of aeration employed for further treatment. The farmer and microbe supplier are testing the settled solids and liquid from the lagoons to determine if P tends to settle to the bottom of the lagoons, leaving the upper liquid layer with a lower P content for land application. Other separation technologies such as dissolved air flotation, fine screening, and higher speed centrifuges, have been tested at this farm and found to be less effective at removing P and solids from the liquid stream. Some of these technologies required a relatively high dose of polymers or chemical flocculants such as ferric sulfate, ferric chloride, or alum. Some of the technologies did not work well because of microbial slime buildup in flushing lanes or other plugging problems.

In 2007, another Dane County farmer pilot tested a solids separation system that used polymer to help remove P and increase solids concentration of separated raw manure solids. While the results of this study varied considerably, the system was able to remove up to approximately 73 percent of the solids, 73 percent of the phosphorus, 52 percent of the nitrogen, and 56 percent of the potassium from the raw manure. These removal percentages were not consistently achieved, however, and the number of samples collected was not adequate to definitively demonstrate the system's performance.

Separated solids could be used in one or more of the following ways as (a) animal bedding, (b) peat moss replacement, (c) compost, (d) dried pellets, (e) supplement in plastics, (f) supplement in fiberboard (currently being tested at the USDA Forest Products Lab), and (g) a more concentrated nutrient source for export to elsewhere in the county or beyond.

3. Manure Drying

Manure drying uses mixing, air, and sometimes heat to dry the solids following solid(s) separation or dewatering. Some processes take this step further to produce a pellet of dried manure. There are at least three manure drying systems in Wisconsin. The Wiese Brother Farm in Brown County uses air, mixing, and recovered heat from a manure combustion process to dry the manure prior to combustion. Also in Brown County, a system has been developed to dry manure using natural gas as a fuel. At the Van Der Geest Farm in Marathon County, manure is screened, dewatered in a screw press, and then dried in a three-pass system using dried manure as a fuel.

FAN Technologies has a drying system that can be used following its screw press separator. This system allows the separated solids to compost and increase in temperature, and the mixing and heat result in a relatively dry product of about 40 percent solids. Drying systems tend to be fairly capital- and operational-cost intensive, and these costs increase with the amount of moisture they remove. Drying systems have the advantage of greatly reducing the volume of the manure, making it more cost-effective to transport as a nutrient source or biofuel. Unless the system is enclosed and the emissions are captured and treated, the drying process can release N, sulfur, carbon dioxide, and moisture to the atmosphere.

D. Phosphorus Removal and Recovery

The major goal of this study is to evaluate solutions that reduce the amount of P that is returned to the Upper Lake Mendota Watershed. Many of the farmers who replied to the survey and who were subsequently interviewed indicated they had or were able to rent sufficient land for land application of manure as a nutrient source without violating county regulations or their nutrient management plan P loading limits. However, this is not true of all Dane County farmers, and additional P reductions may be required as a result of new confined animal feeding operation (CAFO) permits, Lake Mendota priority watershed project reduction goals, the Rock River total maximum daily load (TMDL) development, or revised regulations. Additionally, other factors could affect the ability to landspread manure in the future including development, land rental availability and cost, and trucking inconveniences.

1. Phosphorus Minimization in Feeds

One of the first steps that should be taken when considering removal of a specific compound from a waste stream is to investigate the source of the compound and determine whether the source can be minimized. P is an essential nutrient for bone development and maintenance and for birthing. However, P is sometimes present in the feed at levels that exceed the animals' nutritional requirements. Therefore, manure P source minimization would involve reducing the P content of the feed.

According to a Dane County area feed supplier, the P content of dairy feed has historically been unnecessarily high at about 0.48 percent. Since then, studies have shown that the P content can be lowered without detrimental effects on the animals. Currently, dietary P content for dairy cows is approximately 0.38 percent. Some of the farmers in Dane County have indicated that this feed P reduction has reduced the amount of P in manure considerably. The feed supplier also indicated that dietary supplements are being tested that could reduce the amount of protein the cows require. This, in turn, may reduce the amount of nitrogen in the feed and manure. These supplements have been used successfully in swine and poultry.

2. Phosphorus Removal

The reduction of total phosphorus (TP) from manure wastes can be achieved in one of the following ways:

- a. Solids separation.
- b. Chemical precipitation.
 - metal salts (Fe^{3+} , Al^{3+})
 - struvite [$\text{Mg}(\text{NH}_4)\text{PO}_4 \cdot 6(\text{H}_2\text{O})$]
 - vivianite [$\text{Fe}_3(\text{PO}_4)_2 \cdot 8(\text{H}_2\text{O})$]
 - hydroxyapatite [$\text{Ca}_5(\text{PO}_4)_3(\text{OH})$]
- c. Fluidized bed precipitation process for apatite or other mineral formation and removal.
- d. Enhanced biological removal.

Separation of fresh manure solids may remove as much as 10 to 40 percent of the total P in manure. With the addition of polymer or chemicals, this percentage could be increased. As noted previously, one Dane County farmer plans to pilot test a polymer feed and solids separation system that is being promoted as a phosphorus removal technology. If these solids are subsequently used for animal bedding on the farm, however, some of the P will be recycled rather than removed since spent organic bedding is typically mixed and disposed of with the manure.

Chemical phosphorus removal (CPR) is achieved by the addition of chemical coagulants, typically metal salts, to precipitate dissolved phosphate (PO_4^-). This method has been pilot tested with manure and has also been used full-scale on some farms. It appears to be most widely used in combination with lagoon settling. Farmers report that they can use the higher P, heavier bottom solids as a one-time application on fields that are more remotely located, while the lower-P liquids are applied to fields that are located closer to the lagoon. This technology could be combined with a solids separation technology to reduce the volume of the high P solids even further and make longer-distance trucking more cost-effective. It should be noted that CPR using lagoons may not be as effective if the settled solids are not removed soon after

they settle. If, for example, the bottom solids became anaerobic, some of the P in the settled solids may resolubilize and release into the liquid above.

Because some P becomes soluble in an anaerobic environment, the most effective means of chemical P removal from manure may occur following AD. Thus, AD could be followed by CPR and settling with the settled solids containing a high concentration of P. Alternatively, AD could be followed by solids separation and recovery, and the resultant liquid stream could be treated with CPR. Researchers at UW-Platteville performed several jar tests to examine P removal under these various treatment scenarios. Their methods and results are summarized in Appendix B.

Removal of P by formation of struvite is somewhat similar to CPR. In this case, P is precipitated as magnesium ammonium phosphate ($MgNH_4PO_4 \cdot 6H_2O$). Magnesium addition, ammonium addition, and/or pH adjustment are often necessary to achieve the correct ratios of compounds and conditions for struvite formation. Struvite will then precipitate as a scale onto a downstream surface. Struvite crystallizers can be used to extract the mineral through precipitation on an upflow fluidized bed. The ammonium required for struvite formation is present in fresh manure to some extent and would be present at much higher levels following AD or nonaerated lagoon storage. On the other hand, adjustment of pH may be more cost-effective if it is done upstream of digestion. One distinct advantage of struvite removal is that the resulting P is more concentrated than it is using metal salt precipitation, which would allow it to be used on nearby farms or exported as a nutrient source more easily. This process has been used in municipal wastewater treatment and swine manure management and has been pilot tested for cow manure. Manure pilot tests show a reduced P removal efficiency of approximately 50 percent while 95 percent P removal has been demonstrated in swine applications. Some studies on struvite creation in cow manure have been discontinued because the process proved cost prohibitive. pH adjustment can be difficult because of the buffering capability of manure, and P compounds may need to be modified prior to being available for struvite formation.

According to its Internet site, the Crystalactor[®] process utilizes a fluidized-bed crystallizer for P removal. The treatment process uses a "pellet reactor" partially filled with a suitable seed material such as sand. The wastewater is pumped in an upward direction through the reactor, fluidizing the pellet bed. In order to crystallize the target component on the pellet bed, pH-adjustment and the addition of a reagent may be required. For the Alto Dairy wastewater treatment plant installation in Wisconsin, sand was selected as the seed material and lime is used as the reagent. Calcium phosphate (apatite) crystals are formed on the sand particles. These pellets grow and move toward the reactor bottom where they are discharged from the reactor and disposed of. Fresh sand is added periodically. This process may require a relatively clean wastewater for proper operation; at Alto Dairy, for example, the Crystalactor process follows an activated sludge treatment plant and cloth disk filters, so the water entering the reactor is almost (except for P) clean enough to discharge to surface water.

Enhanced biological phosphorus removal (BPR) can be achieved by carefully controlling aerobic and anaerobic zones within an aerated mechanical waste treatment system to achieve

an enhanced biological uptake of dissolved P. The P is removed from the process along with waste sludge. This sludge needs to be further processed. This technology has been used successfully at many municipal and industrial wastewater treatment plants throughout the United States. BPR generally achieves P removal with lower operation and maintenance (O&M) costs and lower sludge production than CPR, while CPR generally has a higher reliability and, in the case of manure treatment, a significantly lower capital cost. BPR could be considered as part of a full-liquid treatment process following manure solids recovery. However, this process would need to be used in conjunction with a mechanical activated sludge treatment plant, similar to the treatment system employed by MMSD, for example. Waste sludge at MMSD is further processed by AD, thickening, and land application. The high capital and long-term costs associated with building and operating such a facility reduce the viability of BPR for manure treatment. To date, we are not aware of any BPR systems employed for P removal of manure wastes.

E. Biofuel Technologies

Several biofuel technologies were found in the literature that apply to manure management. Ethanol production from manure may eventually be possible. Currently, there are no full-scale cellulosic ethanol plants in the United States, but one is being planned in Georgia. Manure may be a less desirable feedstock for such plants because of its lower cellulose content compared with grass, crop residue, or wood chips. There are installations in Texas and Nebraska that use methane produced from manure digesters to fuel ethanol production plants, and such “co-location” of facilities may be feasible in Dane County. Likewise, it may eventually be possible to cost-effectively produce biodiesel from manure. These types of systems are in the research and development stage with a few larger-scale systems. There is a pilot scale thermochemical conversion facility at the University of Illinois-Urbana that converts swine manure into crude oil. A full-scale system owned by Smithfield Foods in Utah was intended to produce methanol from manure-digester biogas and convert the methanol to biodiesel, but it is no longer operational because of lower-than-expected biogas production and other factors.

F. Byproducts and Residuals Management

The generation and use of byproducts and residuals were discussed under various technologies above. A summary and further discussion is provided in this section.

1. Liquids

The liquid manure stream that is generated following AD can be used directly as a nutrient source and applied to crops using proper management practices, either before or after P removal and/or solids removal. Digestion should remove much of the odor potential associated with the liquid. If further treatment is employed, the liquids may be suitable for use as flushing water in barns or for irrigation water at the farm or on surrounding lands. Golf courses are large irrigation water users and may be interested in highly treated liquids.

Liquids may be made suitable for a groundwater discharge if they receive a high level of treatment. Biochemical oxygen demand (BOD) and total suspended solids (TSS) would need to be reduced to approximately 50 mg/L and total nitrogen (TN) would need to be reduced to approximately 10 mg/L, either by employing an aerated lagoon or activated sludge process or a series of membranes. The groundwater discharge could be accomplished using seepage cells or unlined ponds, unlined wetlands, or infiltration galleries. Groundwater discharges tend to work best if soils are sandy such that they seep well; finding suitable soils in the Upper Mendota watershed may be difficult. A groundwater discharge would be beneficial in terms of the overall water balance in the watershed.

A Wisconsin Pollutant Discharge Elimination System (WPDES) discharge permit for a surface water discharge in the Upper Mendota watershed would be difficult to obtain because of legislation related to the Madison lakes. P would likely need to be removed to very low levels (potentially 0.05 to 0.20 mg/L), and BOD and TSS would need to be below 30 mg/L. Furthermore, it is difficult for a CAFO farm to obtain a WPDES permit for a surface water discharge because of current federal and state CAFO regulations. The Wisconsin Department of Natural Resources (DNR) staff has indicated a willingness to work with Upper Lake Mendota Watershed farms on these issues to facilitate manure management solutions that have a net environmental benefit.

2. Solids

As noted above, separated solids could be used in one or more of the following ways as (a) animal bedding, (b) peat moss replacement, (c) compost, (d) combustion material, (e) supplement in fiberboard, (f) a component of recycled plastic, and (g) a more concentrated nutrient source for export to elsewhere in the county or beyond. There is a concern about Johne's disease organisms or other bacteria in the solids. However, AD, composting, and drying at high temperatures will all destroy Johne's and other organisms.

3. Energy

Biogas produced through AD could be used in a boiler to produce steam, in a boiler to heat the digester, or in a microturbine or engine generator to generate electricity. Microturbines have been employed at a few southern Wisconsin wastewater treatment plants (WWTPs) and landfills. Electricity produced could be used on a farm, at a nearby industry such as one in the Middleton industrial park, or sold to an electric utility. Electric utilities are required by law to generate a certain percentage of their electricity from renewable sources and would be interested in such a project. If an engine generator or microturbine is used, waste heat from the unit would normally be used to heat nearby buildings and/or the digester. Since the biogas also contains carbon dioxide, reduced sulfur compounds, moisture and other nuisance compounds such as siloxanes, it often needs to be treated prior to use.

Treated biogas could also be compressed and tied into a local natural gas distribution system, used by a nearby industry to partially replace natural gas, or used as a vehicle fuel. In the fall of 2007, Dane County solid waste staff visited a dairy farm in southern Michigan where methane gas from an anaerobic digestion system was being treated to

purify the biogas adequately to allow it to be injected into a natural gas pipeline for commercial distribution.

G. Additional Benefits of Various Technologies

1. Addition of Other Feedstocks

A manure digester could be designed to accept material from nearby industries as well as food residuals or fats and oils to maximize the amount of biogas generated. A few area industries were contacted as part of this study. The waste from Industry No. 1 is a high-solids material that is high in organic matter but also contains high sodium and chlorides. The corporation was contacted and indicated that they currently have an outlet for this waste; however they may have a long-range need to find another method to treat or dispose of this waste. A food industry (Industry No. 2) was contacted and it has identified a few waste streams that may be viable substrates. The most likely waste stream is the scum (or “float”) and sludge from its pretreatment system, which currently is land-applied. The industry also has unpackaged and packaged waste product streams that may be considered in a community system; it is currently investigating the feasibility of converting the unpackaged waste product stream into biodiesel. Industry No. 3 recently constructed a waste-grease biodiesel plant that generates a high-strength glycerin waste stream. These local industries are interested in the concept of a community system that would accept their waste streams.

The characteristics of the high strength wastes would need to be carefully evaluated for the following:

- Potential toxicity to AD or composting organisms.
- Nutrients and salt content, which may impact subsequent land application of digested liquids.
- Potential to produce significant biogas.
- Volume in proportion to the anticipated manure volumes.

Industry No. 1 and No. 3 provided general information about their waste streams, which is shown in Table 3.01-1.

	Industry No. 1	Industry No. 3
Flow, gpd	18,000	7,000
Solids		
TS	15.6-23.4%	--
VS	--	91.61%
NH ₃	2,100-3,200 mg/L	non detect
P	3,600-7,100 mg/L	438 mg/L
K	8,300-10,000 mg/L	64,728 mg/L
Na	10,200-19,200 mg/L	231 mg/L

Table 3.01-1 Industrial Waste Streams

Dane County has produced estimates of food scrap generation from households, restaurants, and grocery stores within the County. Household generations, approximately half the total, amounts to about one pound per household per week. Collection would require separate storage and either an additional collection vehicle or a “piggy back” system on existing vehicles. Costs are estimated to be substantial and no Dane County communities either have such a system or are actively working to develop such system. Dane County staff has met with representatives of the trade associations for both the restaurants and the grocery stores within the County. In both cases there was very limited interest in separating food scraps for separate collection.

It may be possible to co-compost yard waste from Waunakee, Madison, or elsewhere, if composting technology is determined to be feasible.

2. Carbon Dioxide Emission Reductions

GHG emissions are an emerging concern in the United States and world because they are believed to contribute to global warming. The primary GHGs of interest for this study include methane, carbon dioxide, and nitrous oxide. Some gases are considered more harmful than others because they undergo oxidation in the atmosphere and are converted to other GHGs. Methane is one of these; it has 21 to 23 times the global GHG effect of carbon dioxide. When renewable resources such as wood or manure are burned, it is considered a “carbon neutral” activity because the source of carbon in these materials is plants within the recent past. Activities that capture carbon dioxide and remove or “retire” it for long periods of time result in a net reduction of GHGs in the atmosphere. This is known as carbon sequestration. Examples include formation of peat bogs, reforestation and reestablishment of grasslands, incorporation of carbon dioxide and biological carbon into the oceans, use of new and recycled wood in building construction, and increasing the net amount of organic matter in soil by incorporating crop residue or other methods, possibly including manure application. Landfilling of organic matter may also sequester carbon.

AD with biogas utilization is generally considered a carbon-positive process because it prevents methane from being produced during lagoon storage of manure and the generation of power replaces the use of fossil fuels. The stabilized organic solids would be reused or returned to the soil. Compared with the current Dane County farming practice of lagoon storage or pile storage of manure, which tend to release methane and nitrogen to the atmosphere, AD is expected to have a net reduction in harmful GHGs.

Combustion is sometimes considered a carbon-neutral technology if natural gas or other petroleum products are not used as a supplemental fuel. With combustion, there would be no return of organic matter to the soil and there would be an increase of carbon emissions to the atmosphere compared with AD. Drying of the manure prior to combustion will release moisture and some carbon, N, and sulfur to the atmosphere unless these emissions are captured and treated. However, capture and treatment of emissions will add significant cost to the project. It appears unlikely that combustion would result in a net reduction of GHGs compared with current Dane County farming practices.

Several entities such as the Chicago Climate Exchange (CCX) purchase and sell carbon and other GHG credits on the open market. The CCX describes itself as a “self-regulatory exchange that administers a voluntary, legally binding pilot program for reducing and trading greenhouse gas emissions in North America....” Members of the CCX include municipalities, industries, utilities, farmers, and others. Members can reduce their emissions and bank and sell their credits or can purchase project-based offsets from methane collection or carbon sequestration projects. Of particular note is CCX’s Agricultural Methane Emission Offsets, which include methane collection (such as AD with energy production) at livestock operations. Offsets are currently issued at a (conservative) rate of 18.25 metric tons of carbon dioxide per ton of methane combusted. CCX prices for carbon dioxide have generally ranged from \$1 to \$5 per metric ton.

Other exchanges, registries, and programs are also available to obtain financial incentives for manure management projects that reduce GHG emissions, generate renewable energy, or a combination of the two. These include the Clean Development Mechanism, the California Climate Action Registry, and the Regional Greenhouse Gas Initiative. These programs, and likely others, should be evaluated if a manure AD is contemplated because the sale of credits may help offset the cost of the project. The prices for carbon dioxide credits through these programs are anticipated to be higher than through the CCX in the short-term.

H. Concerns or Risks of Various Technologies

1. Johne’s Disease

Johne’s disease is a chronic wasting disease that affects animals on many dairy farms throughout the United States. The bacterium (*Mycobacterium paratuberculosis*) that causes the disease can be destroyed if sufficient time and temperature are employed. For AD, a mesophilic digester can destroy the organism in about 28 days. In a thermophilic digester and in composting, the time is reduced to hours. Destruction of the organism should be considered for any community systems that return products to the farms or any systems that result in a product to be distributed to the public.

2. Other Microbes

The management of manure must also consider the potential impact on both human and animal health. While over 100 diseases are recognized in cattle, only a few are of prime importance with respect to manure management. Dane County discussions with faculty at the University of Wisconsin School of Veterinary Medicine and a veterinarian at the Wisconsin Department of Agriculture, Trade, and Consumer Protection have led to a focus on the following:

- The environmental mastitis bacteria
- *Salmonella*
- *Escherichia coli*
- *Campylobacter*

Detailed discussion of these diseases is beyond the scope of this report.

3. Foot Bath Wastewater

Foot baths are commonly used after milking parlors to help keep animal hooves healthy. The foot bath wastewater often contains biocides. For the farms that are in the clusters studied here, the most common biocides are formaldehyde and copper sulfate. Some farms decrease their formaldehyde use in the winter because of lower ventilation rates and subsequent worker safety concerns. Biocides may be harmful to microorganisms in lagoons (e.g., if proprietary specialty microbes are added to the lagoon) and ADs. The quantity and type of biocides should be carefully reviewed to determine whether this wastewater needs to be segregated and removed from the waste stream prior to treatment.

4. Aluminum Oxide, Potassium Sulfite, and Related Compounds on Soils

Some farmers in Dane County indicated a concern with aluminum oxide (alum), potassium sulfite, and other related compounds applied to their farm fields. There is limited information in the literature about this concern. However, at least one state has aluminum limits for land application of biosolids. This should be reviewed in more detail if alum is proposed as a phosphorus removal chemical.

5. Loss of Nutrients and Organic Matter

Farmers who provide their manure to an AD or compost facility without returning digested manure to the farm or those who provide their manure to a combustion system will likely need to purchase at least some supplemental fertilizer for their feed crops. Alternatively, they may elect to reduce their land ownership and purchase feed. This may increase the total cost of operation at some farms.

Another consideration is the loss of organic matter because of the discontinuing of manure application to fields. The impact of not applying manure to fields could be large in systems where crop biomass is not conserved (systems growing primarily corn silage and soybeans and conventional tillage). In these systems, manure replaces the harvested crop residues to help build organic matter, and a decrease in solid organic matter could be expected if manure was no longer applied. However, if recovered solids are used for dairy bedding instead of harvested straw or corn stover, these residues could remain in the fields to protect soil from erosion and to help build organic matter, decreasing the need to replace harvested biomass with the manure.

3.02 ALTERNATIVES FOR STUDY

Eight alternatives have been selected for further study based on the status of technology, potential viability, and ability to meet the project goals. Specifically, each alternative discussed below is believed to meet the following objectives:

- P reduction of 40 percent, minimum.
- Proven at full-scale or at least long-term pilot scale.

Three of the alternatives are for application on individual farms and the remaining five are community solutions. Each of the alternatives is discussed in the following paragraphs.

It is noted that new technologies and methods for managing manure are under development, and significant research is being conducted worldwide on manure management. The technologies considered herein represent viable technologies at the present time.

A. Individual Farm Systems

Individual farm systems will be evaluated using a prototype farm as the basis. The prototype farm will have 500 A.U.s. The herd will be 45 percent dairy milking cows, 37 percent young stock, 7 percent dairy dry cows, and 11 percent other animals (other adult dairy, adult beef, or adult swine). The prototype farm will use straw, sand, sawdust, manure solids, rice hulls, or oat hulls for at least 85 percent of the bedding prior to the installation of manure management solutions, and it will use a scrape or push-type manure collection system. The prototype farm will have a minimum of six months of liquid manure storage, and the current maximum hauling distance for the prototype farm is 5 miles.

- F-1. Fine solids separation with polymer addition.

The raw manure would be dosed with polymer and processed through a fine solids separation unit that would result in two effluent streams. One would be a solids stream containing dewatered solids of approximately 20 to 30 percent dry matter that could be used for composting or other reuse. Solids dewatered in this manner contain anywhere from 40 to 50 percent of the P in the raw manure. Land application of treated liquid manure would provide nitrogen, phosphorus, potassium, organic matter, and trace nutrients to the land partially or wholly replacing commercial fertilizers. Alternative F-1 is shown in Figure 3.02-1.

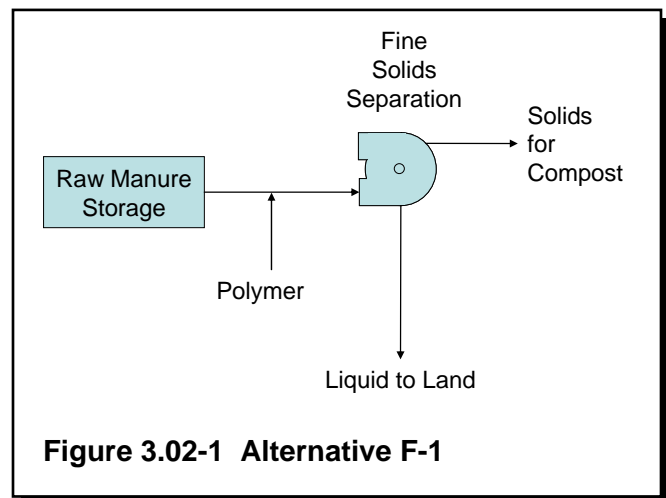
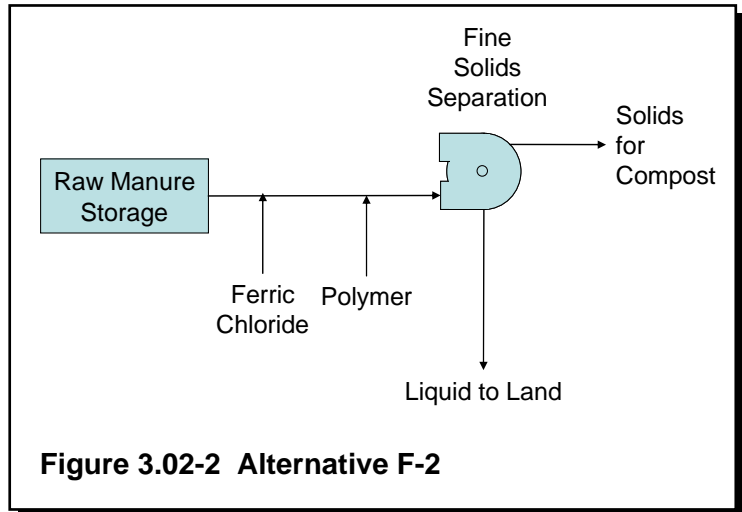

Figure 3.02-1 Alternative F-1

- F-2. Fine solids separation with ferric chloride and polymer addition.

The raw manure would be dosed with polymer and ferric chloride before processing through a fine solids separation unit that would result in two effluent streams. One would be a solids stream containing dewatered solids of approximately 40 to 50 percent dry matter that could be used for composting or other reuse. Solids dewatered in this manner contain anywhere from 60 to 90 percent of the P in the raw manure. Land application of treated liquid manure would provide nitrogen, phosphorus, potassium, organic matter, and trace nutrients to the land partially or wholly replacing commercial fertilizers. Alternative F-2 is shown in Figure 3.02-2.



- F-3. Anaerobic digestion followed by fine solids separation with ferric chloride and polymer addition.

Raw manure would be collected and pumped to a mesophilic (86°F to 104°F) anaerobic digestion tank. Biogas generated during the anaerobic digestion process would be used to generate electricity. Solids would be separated from the digested manure after ferric chloride and polymer addition with fine solids separation. Dewatered solids would be composted or otherwise disposed. The liquid stream from the solids separation would be stored and land-applied. Treated liquid manure would provide nitrogen, phosphorus, potassium, organic matter, and trace nutrients to the land partially or wholly replacing commercial fertilizers. Alternative F-3 is shown in Figure 3.02-3.

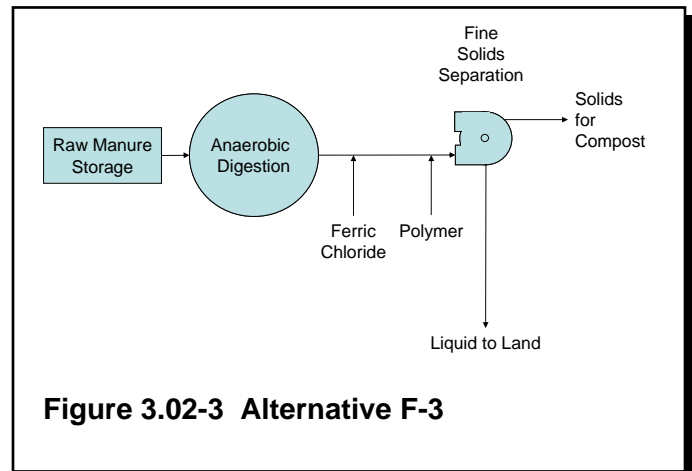

B. Community Systems

All community alternatives must consider the means of manure transportation to the community system. Manure can be pumped or it can be trucked to a community facility. Raw manure would be difficult to pump long distances, but the liquid stream after solids separation could be successfully pumped. The Waunakee Cluster will be evaluated using the assumption that manure will be pumped to a central facility, and the Middleton Cluster will be evaluated using the assumption that manure will be hauled to a central facility. During farm visits, many farmers mentioned the inconvenience of trucking on nearby roads. They were sensitive to issues including spills, timing of manure spreading, wind direction, road conditions, road wear and tear, weekends, holidays, and community events. Pumping also has drawbacks since manure can be difficult to handle and can cause plugging and shortened equipment life.

Evaluations that include hauling manure will be evaluated for 2- and 5-mile one-way trips. This has been changed from the distances specified in the request for proposals because the farms in the Middleton Cluster are located within these distances and they correspond to the 30th and 80th percentiles of the overall reported maximum hauling distances. These distances better reflect what the farmers are currently doing.

For the purposes of this evaluation, it is assumed that sand will be separated from manure prior to delivery at the community site. Sand separation can range from settling in a lagoon to sand settling lanes to mechanical sand separation.

- C-1. Fine solids separation with polymer addition.

Raw manure would be collected at each farm and trucked or pumped to the community processing site. At the community facility, the manure would be dosed with polymer and processed through a fine solids separation unit that would result in two effluent streams, a solids stream and a liquid stream. The solids stream would be composted or disposed of otherwise. The solids stream would contain dewatered solids of approximately 20 to 30 percent dry matter. Solids dewatered in this manner contain anywhere from 40 to 50 percent

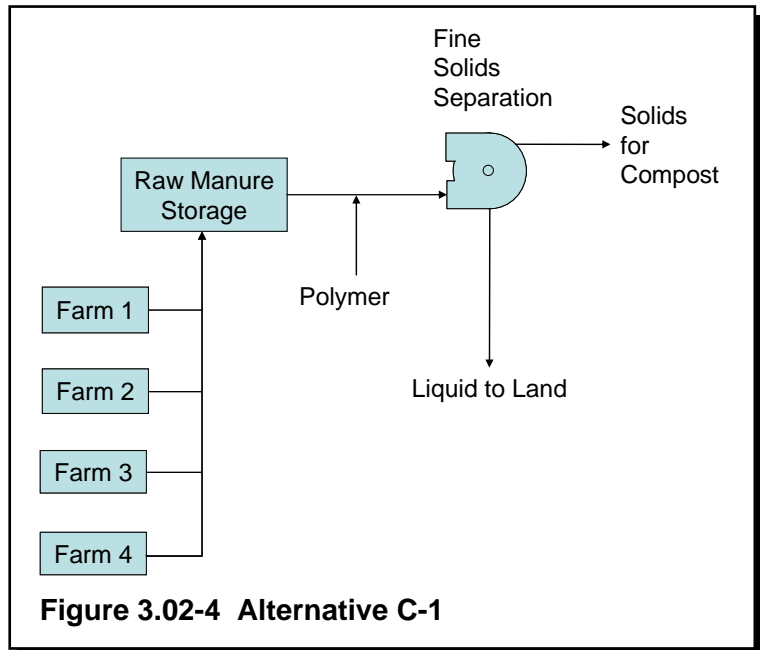

Figure 3.02-4 Alternative C-1

of the P in the raw manure. Treated liquid manure would be pumped or trucked back to the farms to be land-applied to fields for the nutrient values (nitrogen, phosphorus, potassium, organic matter, and trace nutrients). Alternative C-1 is shown in Figure 3.02-4.

- C-2. Fine solids separation with ferric chloride and polymer addition.

Raw manure would be collected at each farm and trucked or pumped to the community processing site. At the community facility, the manure would be dosed with polymer and ferric chloride before processing through a fine solids separation unit that would result in two effluent streams, a solids stream and a liquid stream. The solids stream would be composted or disposed of otherwise. The solids stream would contain dewatered solids of approximately 40 to 50 percent dry matter. Solids dewatered in this manner contain

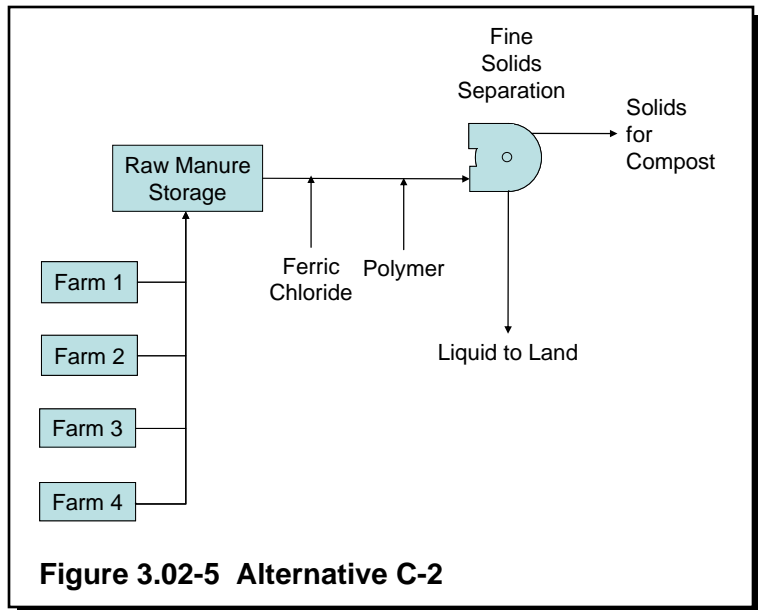

Figure 3.02-5 Alternative C-2

anywhere from 60 to 90 percent of the P in the raw manure. Treated liquid manure would be pumped or trucked back to the farms to be land-applied to fields for the nutrient values (nitrogen, phosphorus, potassium, organic matter, and trace nutrients). Alternative C-2 is shown in Figure 3.02-5.

- C-3. Anaerobic digestion followed by solids separation with ferric chloride and polymer addition.

Raw manure at each farm would be collected and transferred to a 28-day mesophilic anaerobic digestion tank. The tank would be covered with a gas-collecting cover. Biogas generated during the anaerobic digestion process would be used to generate electricity. Solids would be separated from the digested manure with fine solids separation downstream of CPR with ferric chloride and polymer. Dewatered solids could be used for compost or other off-farm uses. Digester detention time and temperature would be selected to provide a high level of weed seed and disease-causing organism destruction because community systems

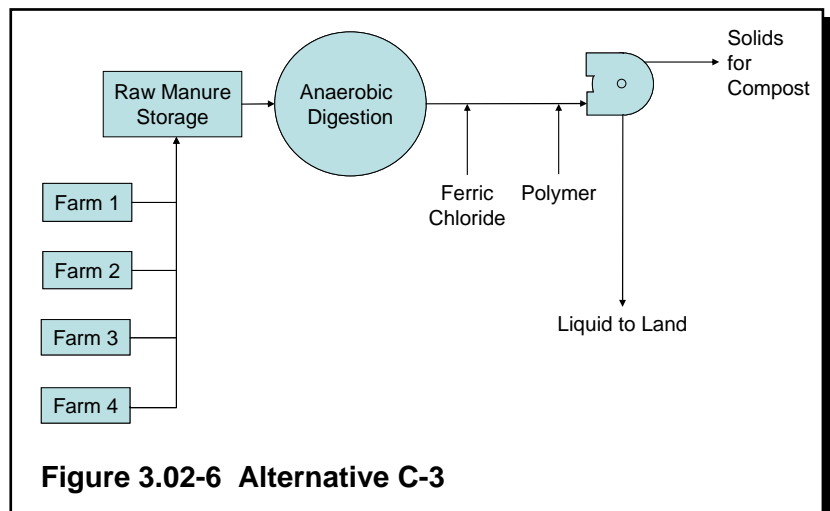

Figure 3.02-6 Alternative C-3

need to prevent the spread of weeds and disease among different farms. Dewatered solids could be used for compost, as soil additives, or in other beneficial reuse products. Treated liquid manure would be pumped or trucked back to the farms to be land-applied to crop fields for use as a nutrient source (nitrogen, potassium, and organic matter). Alternative C-3 is shown in Figure 3.02-6.

- C-4. Fine solids separation with ferric chloride and polymer addition followed by a drier/pelletizer.

Raw manure will be treated with a community fine solids separation unit, and separated liquids will be treated with CPR as described in Alternative F-4; however, CPR will be optional for this alternative depending on the amount of P in the liquid stream. Separated solids will be processed in a drier or pelletizer. The unit will create a product that can be used as a soil additive or possibly a fuel. Farms will be able to use the treated liquid manure on their fields and be able to dispose of the P solids for beneficial reuse. This alternative is shown in Figure 3.02-7.

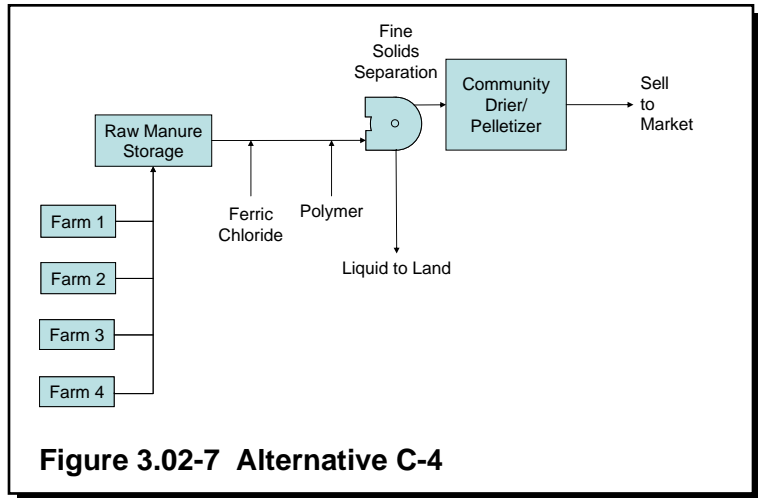

Figure 3.02-7 Alternative C-4

- C-5. Drying followed by combustion.

A portion or all of the raw manure or separated solids would be trucked or pumped to a community site where it would be stored prior to entering the dryer. In the dryer, water would be evaporated to the atmosphere. The resulting solids stream will be combusted creating ash and energy as byproducts. Some nutrients, specifically nitrogen, will be emitted to the atmosphere through the stack. The ash can be used as a soil amendment or possibly as an additive to concrete or asphalt. No byproducts will be returned to the farms, and farms will need to use other means of fertilizing. Alternative C-5 is shown in Figure 3.02-8.

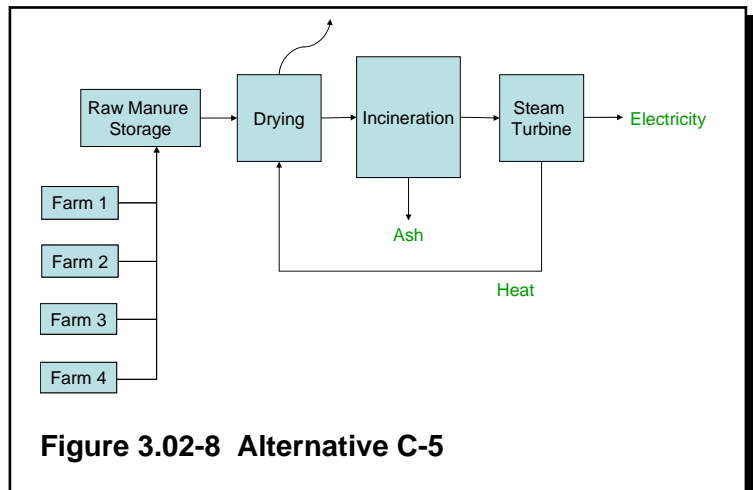

Figure 3.02-8 Alternative C-5

SECTION 4
DESIGN BASIS AND FINANCIAL EVALUATIONS

This section presents our opinion of cost evaluations of the eight manure management alternatives described in Section 3. A description of the facilities included in each alternative is presented, and opinions of capital, operational and maintenance (O&M), and overall life cycle costs are developed in this section. Cost sensitivity analyses are presented with respect to major O&M cost variables.

4.01 DESIGN BASIS

Chapters 2 and 3 discussed the current characteristics of each cluster and the assumed characteristics of the prototype farm in general. Based on that information, the preliminary design basis for each of the management alternatives was developed (Table 4.01-1). This design basis was used to develop preliminary facility and equipment requirements, which were then used to obtain proposals from manure management equipment and system providers and vendors.

The design basis was developed using the information collected with the farm surveys, and additional references were used to complete the design basis when the survey farm data was either incomplete or varied too much to rely on. These references included *Publication A2809 Nutrient Application Guidelines for Field, Vegetable, and Fruit Crops* in Wisconsin issued by the UW Extension and the *Nutrient Management Fast Facts* brochure from the Nutrient and Pest Management Program at the UW Extension. Most significantly, the solids content of the manure was assumed to be as presented in *Publication A2809*, Table 9.2.

It is noted that these design conditions are preliminary, and additional data collection, manure characterization, and quantity estimation should be conducted before proceeding to an implementation phase. For example, the manure production rate for the Waunakee Cluster was approximately 50 percent higher than for the Middleton Cluster (9.9 dry lbs/day/A.U. vs. 6.4 dry lbs/day/A.U.). While both of these values are within the normal range of manure production for dairy cattle of 6 to 10 lbs/day/A.U., this variation was not expected and is not readily explained. The Middleton Cluster does have higher numbers of young cattle and handles more of the manure in a dry form versus liquid form. Inaccurate manure estimation quantities might explain most of the discrepancy.

To develop facility requirements (sizes and capacities) for each of the three design conditions (individual farms, Waunakee Cluster, Middleton Cluster), a 25 percent allowance in the total manure quantities was included to provide capacity for additional manure loadings and/or alternate feed stocks such as industrial wastes. However, in the following sections, the mass balances and figures presented for each manure management alternative do not include this 25 percent allowance to better reflect the anticipated manure quantities. The quantities do, however, reflect the anticipated growth of the farms represented in the alternative analyses.

The alternatives included below for both the individual farms and the farm clusters assume that sand separation has already taken place prior to the equipment and processes described in the following sections for each of the management alternatives. All of the alternatives include some

TABLE 4.01-1

PRELIMINARY DESIGN BASIS

	<u>Prototype Farm</u>	<u>Waunakee Cluster</u>	<u>Middleton Cluster</u>
General Characteristics			
Total Number of A.U. (2007)	500	3,145	3,813
Anticipated Percent Growth through 2012 (Percent)	7	9	4
Total Number of A.U. (2012)	535	3,434	3,966
Additional Growth Allowance (Percent)	25	25	25
Design A.U.	669	4,293	4,957
Manure Production Rate (dry lbs/day/A.U.) ^a	6.3	9.9	6.4
Liquid Manure Generation^b			
Percentage of Total Manure Solids	46	80	50
Mass of Manure Solids (dry lbs/day)	1,938	34,000	15,862
Solids Concentration of Manure (Percent)	6.0	6.0	6.0
Volume of Liquid Manure (gallons/day)	3,873	67,946	31,699
Nutrient Loadings:			
N (lbs/day)	93	1,631	761
P ₂ O ₅ (lbs/day)	35	612	285
K ₂ O (lbs/day)	77	1,359	634
S (lbs/day)	16	285	133
Solid Manure Generation^b			
Percentage of Total Manure Solids	54	20	50
Mass of Manure Solids (dry lbs/day)	2,275	8,500	15,862
Solids Concentration of Manure (Percent)	24	24	24
Volume of Solid Manure (gallons/day)	1,137	4,247	7,925
Nutrient Loadings:			
N (lbs/day)	47	177	330
P ₂ O ₅ (lbs/day)	24	89	165
K ₂ O (lbs/day)	43	159	297
S (lbs/day)	7	27	50
Total Manure Generation Summary			
Total Mass (dry lbs/day)	4,213	42,500	31,724
Total Solids Content (Percent)	10.1	7.1	9.6
Total Manure Production (wet tons/day)	21	301	165
Total Manure Volume (gal/day)	5,010	72,192	39,624
Total Nutrient Loadings			
N (lbs/day)	137	1,808	1,091
P ₂ O ₅ (lbs/day)	59	700	450
K ₂ O (lbs/day)	120	1,518	931
S (lbs/day)	23	312	183

^a Based on survey data.

^b Liquid manure is generally flushed as a liquid or semi-liquid and stored in a tank or lagoon; solid manure is generally scraped and stored in a stack or pile on-site.

level of storage prior to the alternative technologies employed, and at a minimum, sand would tend to settle within such storage structures.

One alternative that was not included, but that has been employed on an individual farm basis, is simple solids separation (no polymer or other chemical addition) using screw presses or similar equipment. This type of equipment may be used to recover some of the fiber in the manure, and the fiber can often be reused as animal bedding even without digesting or otherwise treating the solids. However, the amount of P removed in such a system (typically 20 to 30 percent) is lower than required to meet the County's goals for phosphorus reduction. Therefore, simple solids separation without any chemical addition was not evaluated in this report. In addition, new technologies and methods for managing manure are under development, and significant research is being conducted world wide on manure management. The technologies considered herein represent viable technologies at the current time, and we understand that new technologies may be developed in the near future that could change these evaluations.

4.02 INDIVIDUAL FARM ALTERNATIVES–DETAILED DESCRIPTIONS

This chapter provides a discussion of the equipment, tanks, building, and related construction elements required for each of the individual farm alternatives. In the following analyses, quantities, performance, and similar information provided should be considered as preliminary.

A. Alternative F-1: Fine Solids Separation with Polymer Addition

Raw manure would be collected at a central manure receiving pit sized to hold two days of manure generation. Manure would be pumped to the solids separation equipment, and polymer would be injected into the pipe prior to the separation equipment to improve solids capture. The polymer system includes a polymer makeup and delivery system that uses emulsion polymers (liquid dry polymers could also be used) delivered and stored in portable 2,200-pound (about 300 gallons) tote containers. Polymer would be diluted with fresh water prior to being mixed into the manure.

Separated solids would be transferred to a covered storage space protected from the elements, where the solids could be stored for up to three months as needed. The liquid portion of the separated manure would be pumped to storage. The storage lagoon would be sized for six months of storage. Cost opinions assume there is an existing raw manure storage lagoon, which would be converted to storage for effluent liquids. The estimated volume of this existing storage lagoon is 1 million gallons based on manure production rates. In this alternative, the addition of polymer water and dewatering equipment wash water would require additional storage capacity, resulting in a total storage volume requirement of approximately 3-million gallons. Therefore, a new 2-million-gallon storage lagoon is required. The liquid is assumed to be land-applied by trucking on nearby land (reduced trucking compared to the existing operations) since the P content is significantly less than the phosphorus content of the raw sludge.

This system will be equipped with a nonpotable water (NPW) system incorporating a storage tank and booster pumps to feed wash water to the fine solids separation unit and to feed dilution water to the polymer system. The storage tank would be filled from the farm's well.

Figure 4.02-1 shows the mass balance through the solids separation process. The mass balance was generated using manufacturer's data for system performance. Based on this data, about 77 percent of the raw manure volume is conveyed to liquid storage along with the water added for polymer dilution and screen wash water, and the liquid portion contains about 55 percent of the solids, N, P, and K. Polymer dilution water and wash water are assumed to add negligible solids and nutrients.

The polymer demand for this system is about 60 lbs/day. The system would also require approximately 3,800 gallons of polymer makeup water and 8,400 gallons of screen wash water per day. The system is designed to operate approximately 40 to 50 hours/week and is anticipated to require 0.5 full-time staff for operations and maintenance.

B. Alternative F-2: Fine Solids Separation with Ferric Chloride and Polymer Addition

This alternative is very similar to Alternative F-1. The basic difference is the addition of ferric chloride to the solids separation equipment feed line, which improves P and solids capture, resulting in higher P in the solids and lower solids and nutrients in the liquid portion. The ferric chloride feed system would be similar to the polymer feed system with the exception that dilution water is not required for the ferric system.

A new solids storage structure will be constructed to hold about one month of solids. This storage time is less than in Alternative F-1 and was assumed because of the higher nutrient value of the solids and the subsequent increased likelihood of transporting the solids off-site more readily than in Alternative F-1. The solids can be land-applied, sold to another end user, or composted. We have assumed the liquids would be applied to nearby fields using irrigation equipment. We have included traveling spray guns, approximately one-half mile of underground piping to nearby fields, and a 100 hp irrigation pump in our cost opinions. The storage lagoon would be sized for about three months of storage, which will be approximately 1-million gallons. Cost evaluations assume that the existing 1-million-gallons storage lagoon will be converted to storage for treated liquids. The duration for liquids storage has been reduced because liquids will have low enough nutrient content to allow spray application to growing crops.

The wash water needs of the separation equipment would probably be partially met by recycling water from the separation equipment. The effluent water has fairly low solids and nutrients, and in similar applications, the equipment vendor has indicated a significant savings by recycling water to clean the equipment screens.

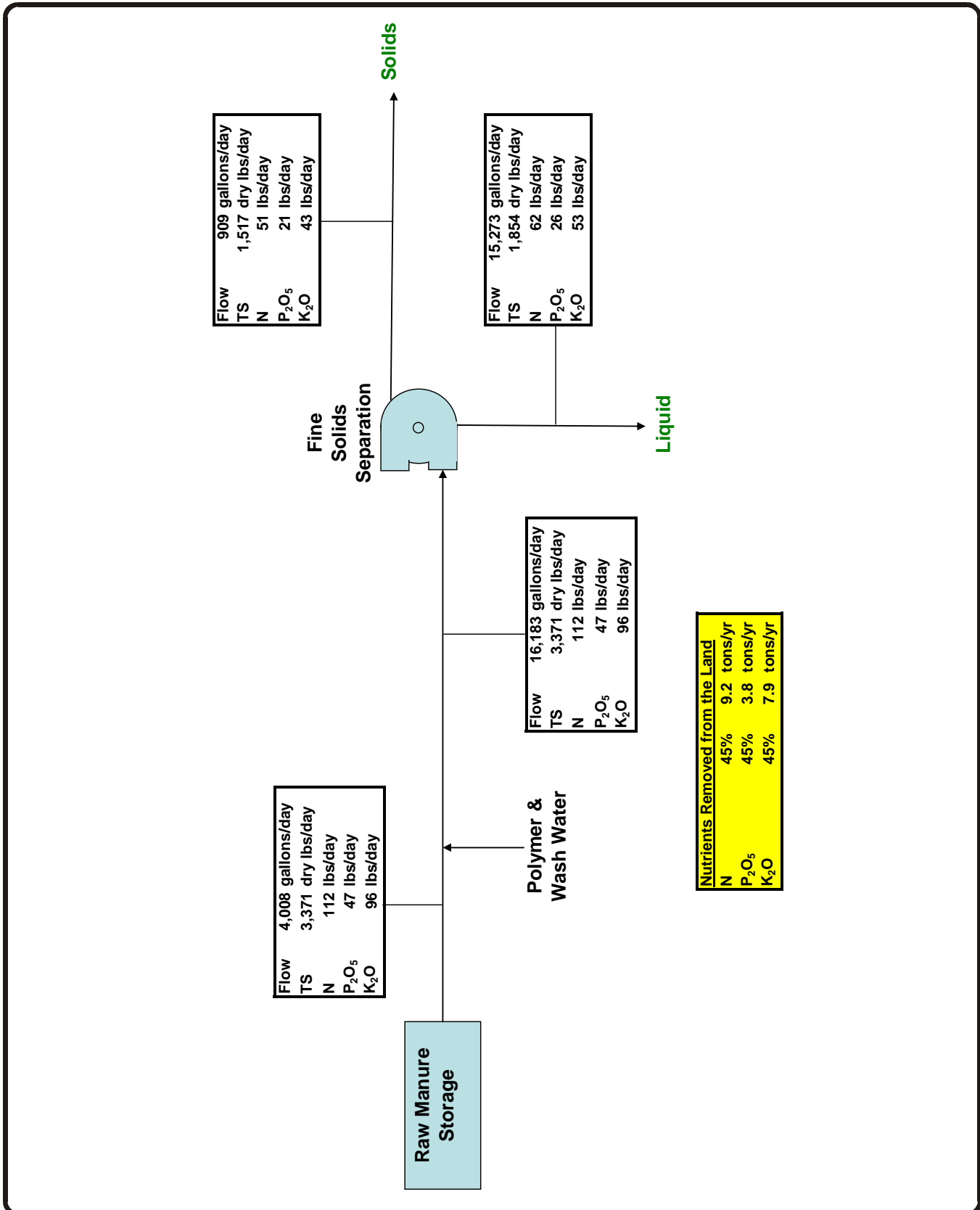

**ALTERNATIVE F-1
FINE SOLIDS SEPARATION WITH POLYMER ADDITION
COMMUNITY MANURE MANAGEMENT FEASIBILITY STUDY
DANE COUNTY, WISCONSIN**



**FIGURE 4.02-1
1-124.005**

Figure 4.02-2 shows the mass balance through the solids separation process. These numbers were generated using manufacturer's data. Based on the manufacturer's estimates, the liquid portion would contain approximately 5 percent of the solids, 55 percent of the N, 15 percent of the P, and 55 percent of the K. The solids portion is 23 percent of the volume and contains approximately 95 percent of the solids and 85 percent of the P. Polymer dilution water and wash water are assumed to add negligible solids and nutrients.

The ferric chloride and polymer usage for this alternative is anticipated to be about 250 lbs/day and 30 lbs/day, respectively. The system would require approximately 1,900 gallons of polymer makeup water and 5,200 gallons of screen wash water per day. The system is designed to operate approximately 40 to 50 hours/week and is anticipated to require 0.5 full-time staff for operations and maintenance.

C. Alternative F-3: Anaerobic Digestion Followed by Fine Solids Separation with Ferric Chloride and Polymer Addition

Raw manure would be collected at a central location on-site and pumped to an anaerobic digester on a continuous basis. The digester would be sized for a 28-day detention time to provide adequate destruction of disease organisms and is assumed to operate at mesophilic temperatures in the range of 90° to 100°F. The digester would be an aboveground covered tank equipped with mixing and heating equipment. The anaerobic digester cover will be designed to collect biogas and would be equipped with the proper gas safety equipment and devices necessary for systems generating methane gas. Biogas would be delivered to engine-generation equipment designed to burn biogas and generate electricity. The electricity would be used on the farm to supplement demand. Heat would be recovered from the engine and used to maintain the digester temperature and provide building heat.

Anaerobically digested manure would then be pumped to a solids separation system identical to that described for Alternative F-2. Figure 4.02-3 shows the mass balance through the anaerobic digestion and solids separation processes. These numbers were generated using anticipated removal rates for anaerobic digestion and manufacturer's data for the solids separation process. It was assumed that the raw manure is about 90 percent volatile and that the anaerobic digester will destroy 35 percent of the volatile solids in the raw manure. The anticipated effluent total solids concentration from the digester is approximately 2,300 dry lbs/day. The nutrient content of the manure is expected to be conserved through the digester, although there will be some changes in the form of the nutrients, especially N and P. After solids separation, about 84 percent of the raw manure volume is conveyed to liquid storage along with the water added for polymer dilution and screen wash water. The liquid portion contains 5 percent of the solids, 55 percent of the N, 15 percent of the P, and 55 percent of the K. The solids portion contains 16 percent of the initial volume, 95 percent of the solids, and 85 percent of the P. Polymer dilution water and wash water are assumed to add negligible solids and nutrients.

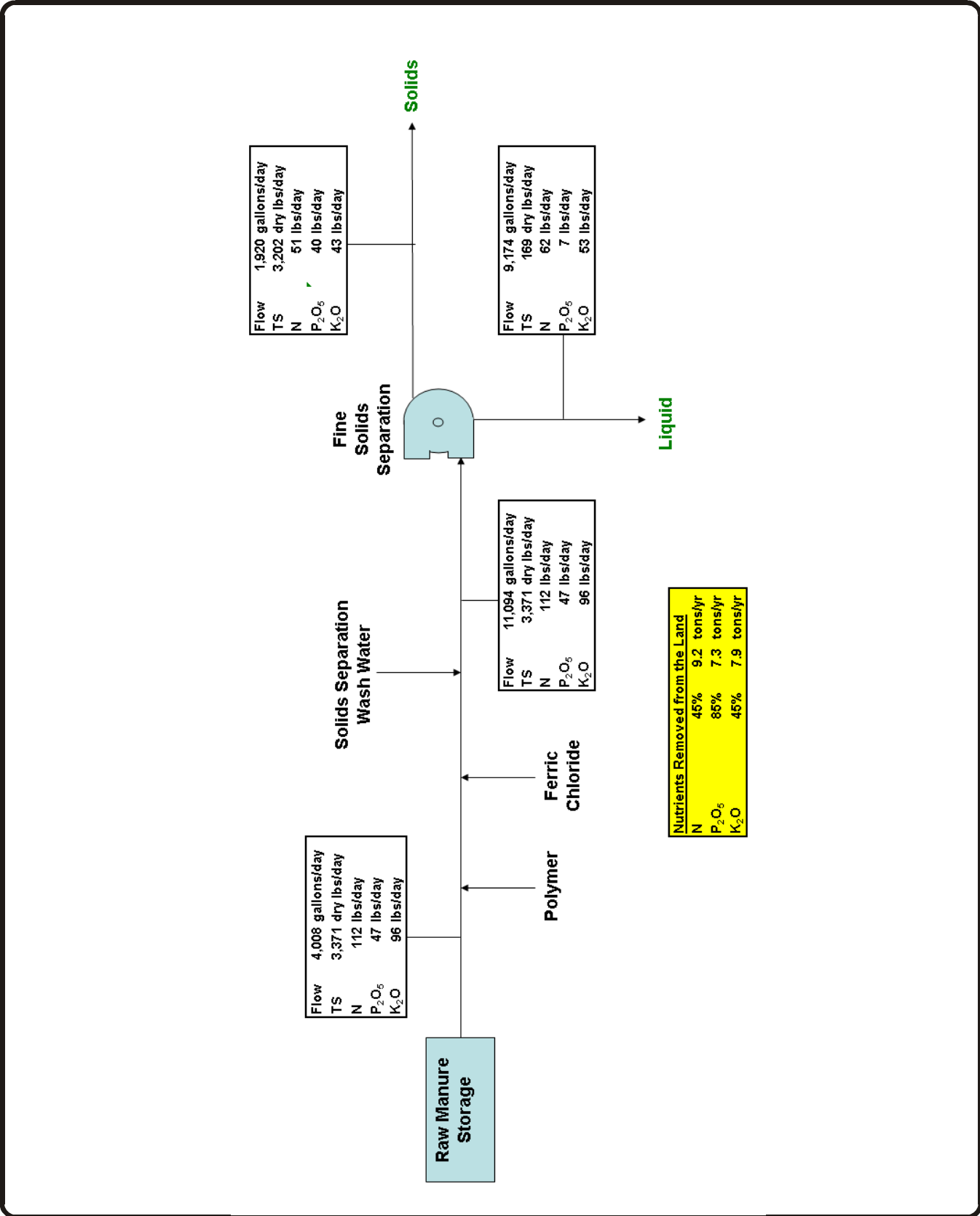

ALTERNATIVE F-2
FINE SOLIDS SEPARATION WITH FERRIC CHLORIDE AND POLYMER ADDITION
COMMUNITY MANURE MANAGEMENT FEASIBILITY STUDY
DANE COUNTY, WISCONSIN



FIGURE 4.02-2
1-124.005

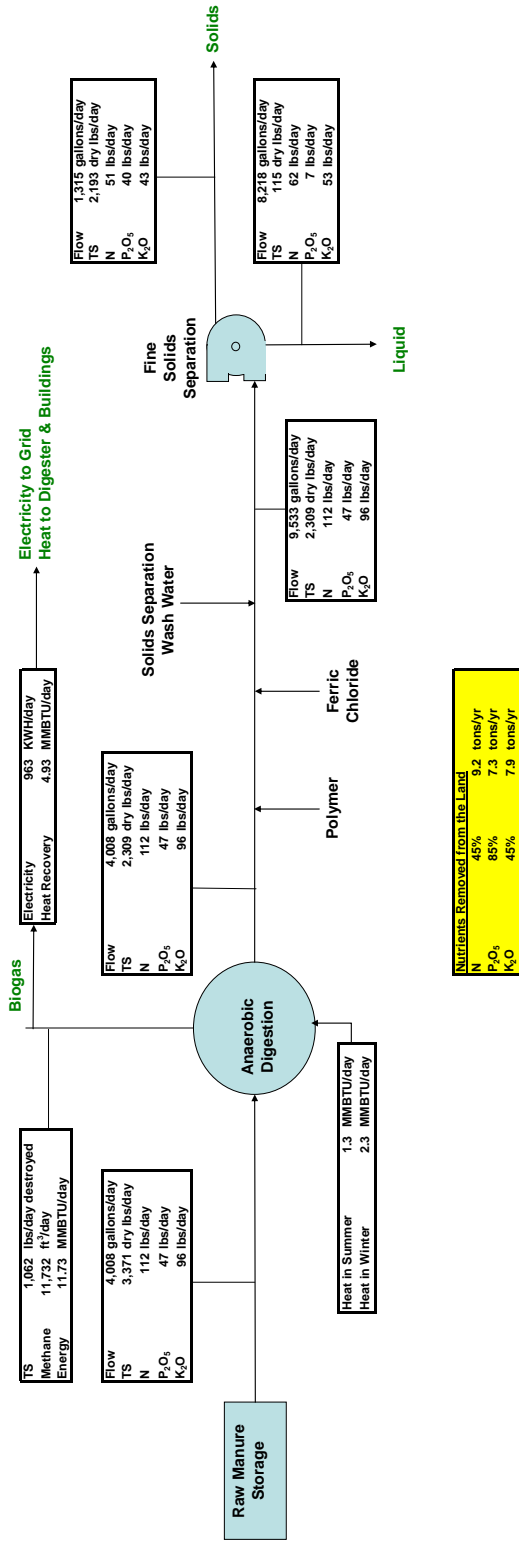

**ALTERNATIVE F-3
ANAEROBIC DIGESTION FOLLOWED BY FINE SOLIDS
SEPARATION WITH FERRIC CHLORIDE AND POLYMER ADDITION
COMMUNITY MANURE MANAGEMENT FEASIBILITY STUDY
DANE COUNTY, WISCONSIN**



**FIGURE 4.02-3
1-124.005**

The ferric chloride and polymer demands for the system are about 170 lbs/day and 22 lbs/day, respectively. The system would require approximately 1,300 gallons of polymer makeup water and 4,200 gallons of screen wash water per day. The system is designed to operate approximately 40 to 50 hours/week and is anticipated to require 1.0 full-time staff for operations and maintenance.

4.03 CLUSTER ALTERNATIVES–DETAILED DESCRIPTIONS

This section provides a detailed discussion of the equipment, tanks, building, and related construction elements required for each of the cluster alternatives.

A. Common Facilities–All Alternatives

For each of the cluster alternatives, raw manure must be collected at each of the cluster farms and transported to a central facility for processing by one of the five alternatives (C-1 through C-5). The facilities required at each farm are independent of the technology employed at the central facility and are required for all alternatives. These facilities are described below for the Waunakee and Middleton clusters.

1. Waunakee Cluster

The Waunakee Cluster would use pumping stations to convey raw manure at each farm to the central processing facility, as the three farms (Farms 4, 32, and 150) included in this cluster are relatively close to each other. The central facility was assumed to be located at Farm 32 because this farm has more of the desired infrastructure already in place. Farms 4 and 150 would pump their manure on a regular basis to a raw manure storage tank at Farm 32. Conveyance systems would be designed to drain as much as possible after pumping ceases to reduce the potential of lines plugging with manure that has settled in the lines.

Manure would be processed through the community facility, and the remaining liquids would be distributed among the three farms for land application. Conveyance of water to the farms would be through the same pipeline that is used for raw manure delivery. Valves at the community facility and the farms would be used to control the flow path of the manure.

The following additional infrastructure would be necessary at each farm:

- a. Farm 32: Additional force main (on-site) and a pumping station.
- b. Farm 150: Force main between Farm 150 and Farm 32 of approximately 1,750 feet, short-term storage for raw manure, and a raw manure pumping station. The existing 12 months of storage will be converted to finished liquid storage.

- c. Farm 4: Force main between Farm 4 and Farm 32 of approximately 3,500 feet, six months of storage for finished liquid storage, and a manure pumping station. Six months of storage for this farm is estimated to be a 7.5-million-gallon lagoon.

This infrastructure will be necessary for each of the alternatives except for Alternative C-5 (Combustion). Since there will be no liquid effluent stream from Alternative C-5 (Combustion), six months storage will not be necessary for Farm 4 and short-term storage will not be necessary for Farm 150; however, the other infrastructure will still be necessary.

For Alternatives C-2 (Fine Solids Separation/Ferric), C-3 (Anaerobic Digestion), and C-4 (Drying), irrigation equipment will be necessary at each farm if the farm does not already have a means of applying liquids to fields. This document assumes that irrigation equipment is necessary at each farm.

2. Middleton Cluster

The Middleton Cluster (Farms 89, 112, 142, 145, 156, 176, and 195) would use trucks to haul the manure to the community facility. Ideally, the community facility would be located along the Highway 12 corridor near County Highway K. Manure would be trucked to the community facility from each of the farms, and liquid residuals would be trucked back to each of the farms for storage and land application. The existing raw manure storage at each of the farms would be converted to liquid residual storage, and one of the other existing storage structures or a new storage structure would be used for raw manure storage prior to hauling to the community facility. The raw manure storage on each farm should provide approximately one week of storage or more.

The following additional infrastructure would be necessary at the farms as noted:

- a. Farm 89: One week of storage for raw manure prior to hauling to community facility.
- b. Farm 112: None.
- c. Farm 142: One week of storage for raw manure prior to hauling to community facility.
- d. Farm 145: None.
- e. Farm 156: Six months of storage for liquid residuals. Storage will be sized to hold 10 percent of the liquid residual from the treatment system. This percentage was selected because this farm has 10 percent of the A.U. in this

cluster. This lagoon is roughly 2-million gallons, but it varies depending on the alternative.

- f. Farm 176: One week of storage for raw manure prior to hauling to community facility.
- g. Farm 195: One week of storage for raw manure prior to hauling to community facility.

This infrastructure would be necessary for each of the alternatives except for Alternative C-5. Since there will be no liquid effluent stream from Alternative C-5, raw manure storage would not be necessary for Farm 89, Farm 142, Farm 176, and Farm 195, and six months of storage for liquid residuals would not be necessary for Farm 156.

For Alternatives C-2, C-3, and C-4, irrigation equipment will be necessary at each farm to spray irrigate returned water on nearby fields.

B. Alternative C-1: Fine Solids Separation with Polymer Addition

Raw manure will be delivered to a central manure receiving pit at the community facility sized to provide approximately one week of raw manure storage. The polymer dosing and solids separation equipment is similar to that described for Alternative F-1, with the exception that the equipment would be sized to handle the higher loadings, and a dry polymer system would likely be included in lieu of the emulsion polymer system for Alternative F-1. For economy reasons, dry polymer systems are normally used for larger applications with significant polymer usage.

Approximately one month of liquids residual storage will be constructed at the cluster site, which amounts to 4.5-million gallons of liquid storage in the Waunakee Cluster and 3.1-million gallons of storage in the Middleton Cluster. A new structure will be constructed to hold three months of solids at the processing facility site. The solids can be land-applied or composted. Liquids will be land-applied by the cluster farms.

Figures 4.03-1 and 4.03-2 show the mass balance through the solids separation process for the Waunakee and Middleton Clusters, respectively. Based on this information, approximately 77 percent of the initial volume and 55 percent of the solids, N, P, and K will end up in the liquid portion of the separated manure.

The estimated polymer demand for the Waunakee cluster is 600 to 650 lbs/day. The system would also require approximately 38,000 gpd of polymer makeup water and 38,000 gpd of screen wash water. The polymer demand for the Middleton cluster is estimated at 450 to 500 lbs/day. The system would require approximately 29,000 gpd of polymer makeup water and 42,000 gpd of screen wash water. Both systems were sized to operate 40 to 50 hours/week, and both systems are anticipated to require two full-time staff for operation and maintenance.

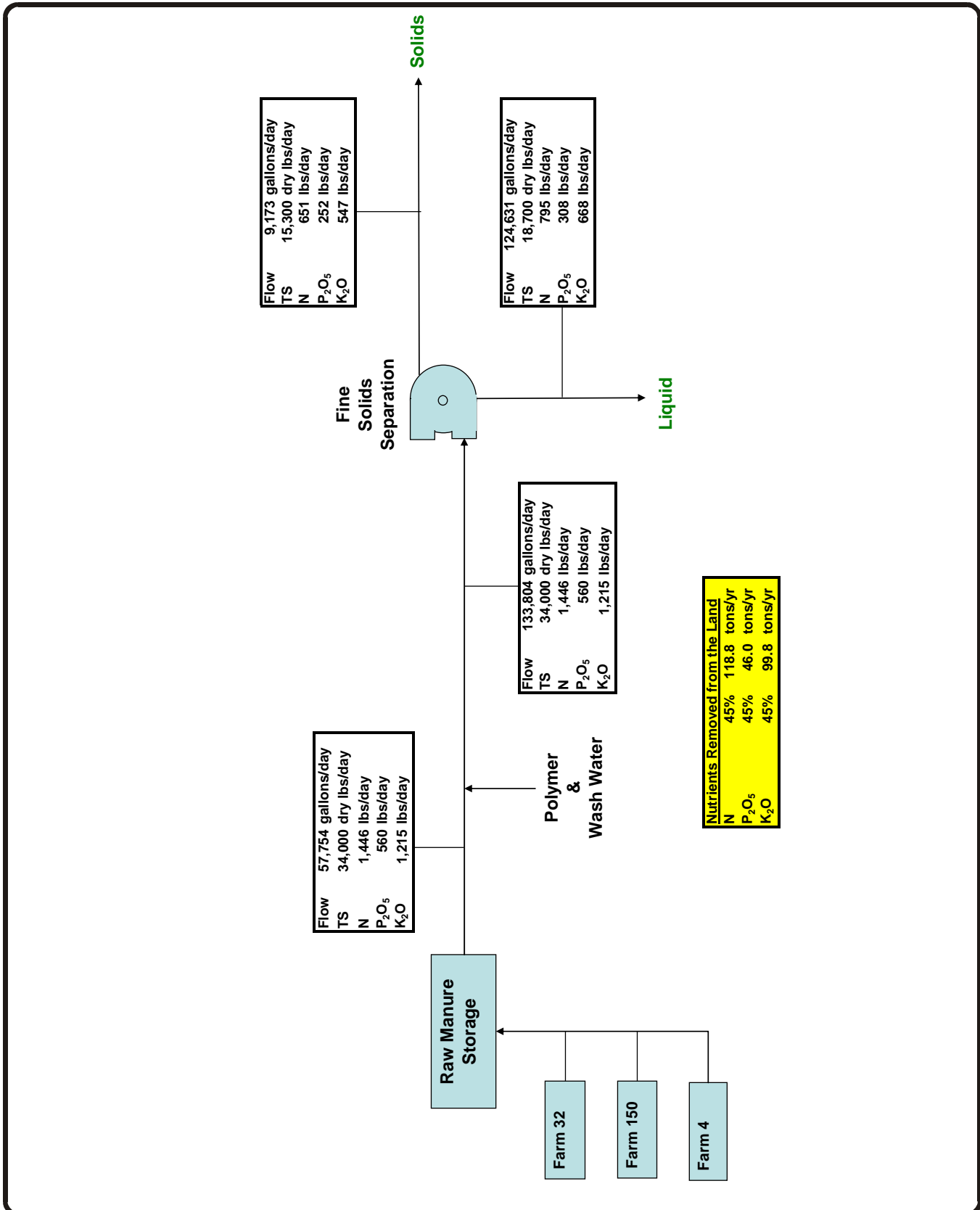

ALTERNATIVE C-1W (WAUNAKEE)
 FINE SOLIDS SEPARATION WITH POLYMER ADDITION
 COMMUNITY MANURE MANAGEMENT FEASIBILITY STUDY
 DANE COUNTY, WISCONSIN



FIGURE 4.03-1
 1-124.005

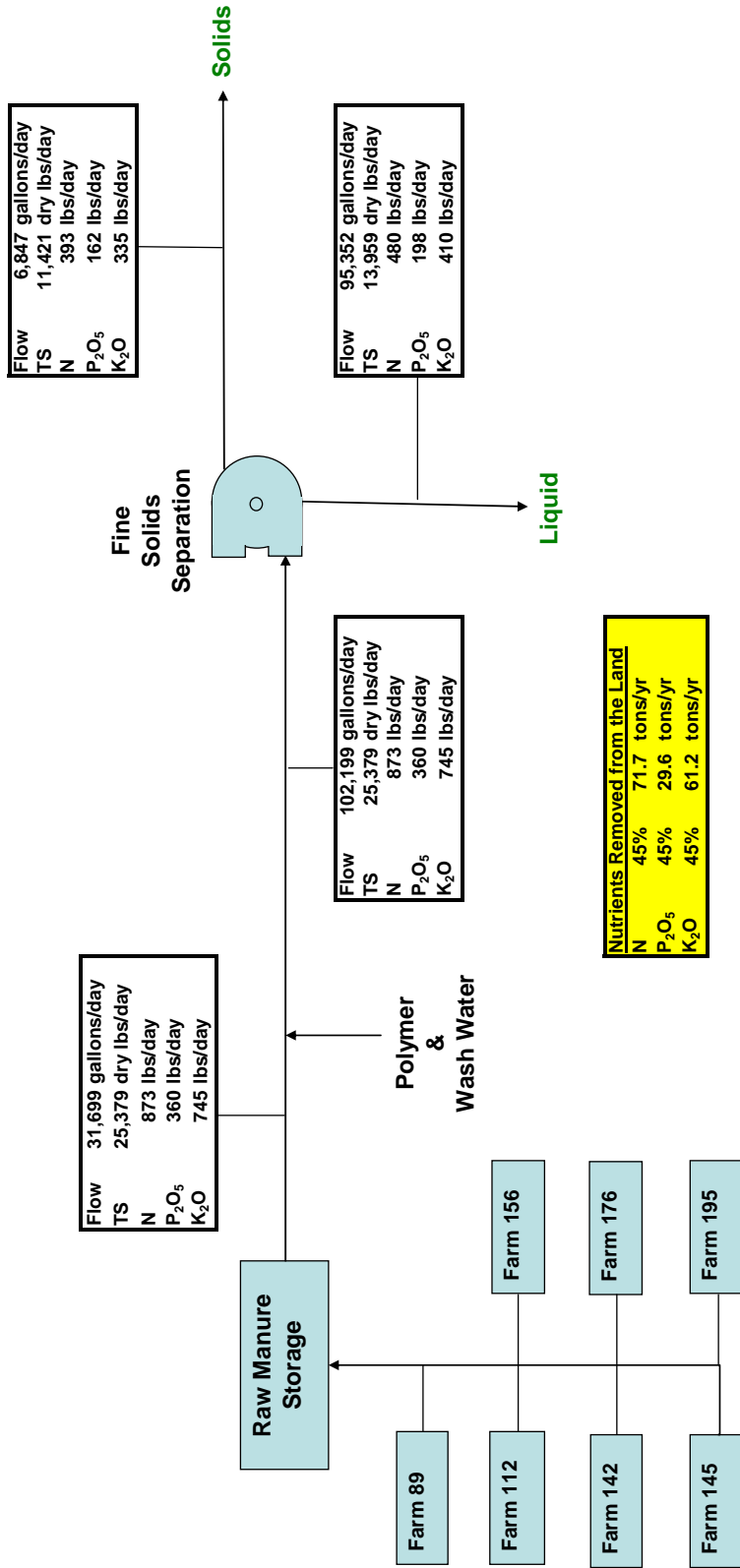

ALTERNATIVE C-1M (MIDDLETON)
 FINE SOLIDS SEPARATION WITH POLYMER ADDITION
 COMMUNITY MANURE MANAGEMENT FEASIBILITY STUDY
 DANE COUNTY, WISCONSIN



FIGURE 4.03-2
 1-124.005

C. Alternative C-2: Fine Solids Separation with Ferric Chloride and Polymer Addition

Raw manure will be delivered to a central manure receiving pit at the community facility sized to provide approximately one week of raw manure storage. The polymer dosing and solids separation equipment is similar to that described for Alternative F-2, with the exception that the equipment would be sized to handle the higher loadings, a dry polymer system would likely be included in lieu of the emulsion polymer system for Alternative F-2, and a bulk ferric chloride storage facility would be included in lieu of chemical storage in totes or drums.

Approximately 3.1-million gallons of storage will be necessary for liquids storage in the Waunakee Cluster, and 2.3-million gallons of storage will be necessary for liquids storage in the Middleton Cluster. A new structure will be constructed to hold one month of solids. The solids can be land applied, sold to another end user, or composted. The amount of solids storage has been reduced for this alternative and others that produce similar solids because of the increased flexibility in solids disposal. Liquids will be spray irrigated by the cluster farms.

Figures 4.03-3 and 4.03-4 show the mass balance through the solids separation process for the two clusters. These balances were generated using manufacturer’s data for system performance. Based on this information, 75 to 85 percent of the raw manure volume is conveyed to liquid storage along with the water added for polymer dilution and screen wash water. The liquid portion contains less than 5 percent of the solids, approximately 15 percent of the P, and 55 percent of the N and K for both clusters.

The anticipated average polymer and ferric chloride demands for the Waunakee cluster are 320 lbs/day and 2,600 lbs/day, respectively. The system would also require approximately 19,000 gallons of polymer makeup water and 38,000 gallons of screen wash water per day. A portion of the wash water flows are assumed to be recycled water from the separator.

The anticipated average polymer and ferric chloride demands for the Middleton cluster are 240 lbs/day and 1,900 lbs/day, respectively. The system would also require approximately 15,000 gpd of polymer makeup water and 42,000 gpd of screen wash water. Both systems are designed to operate 40 to 50 hours/week, and both systems are anticipated to require two full-time staff for operations and maintenance.

D. Alternative C-3: Anaerobic Digestion Followed by Solids Separation with Ferric Chloride and Polymer Addition

Raw manure will be delivered to a central manure receiving pit at the community facility sized to provide approximately one week of raw manure storage. The digestion, biogas utilization, chemical addition, and solids separation and equipment would be similar to that described for Alternative F-3. In addition to providing electricity for use on the farm, however, excess electricity is assumed to be sold to the local utility.

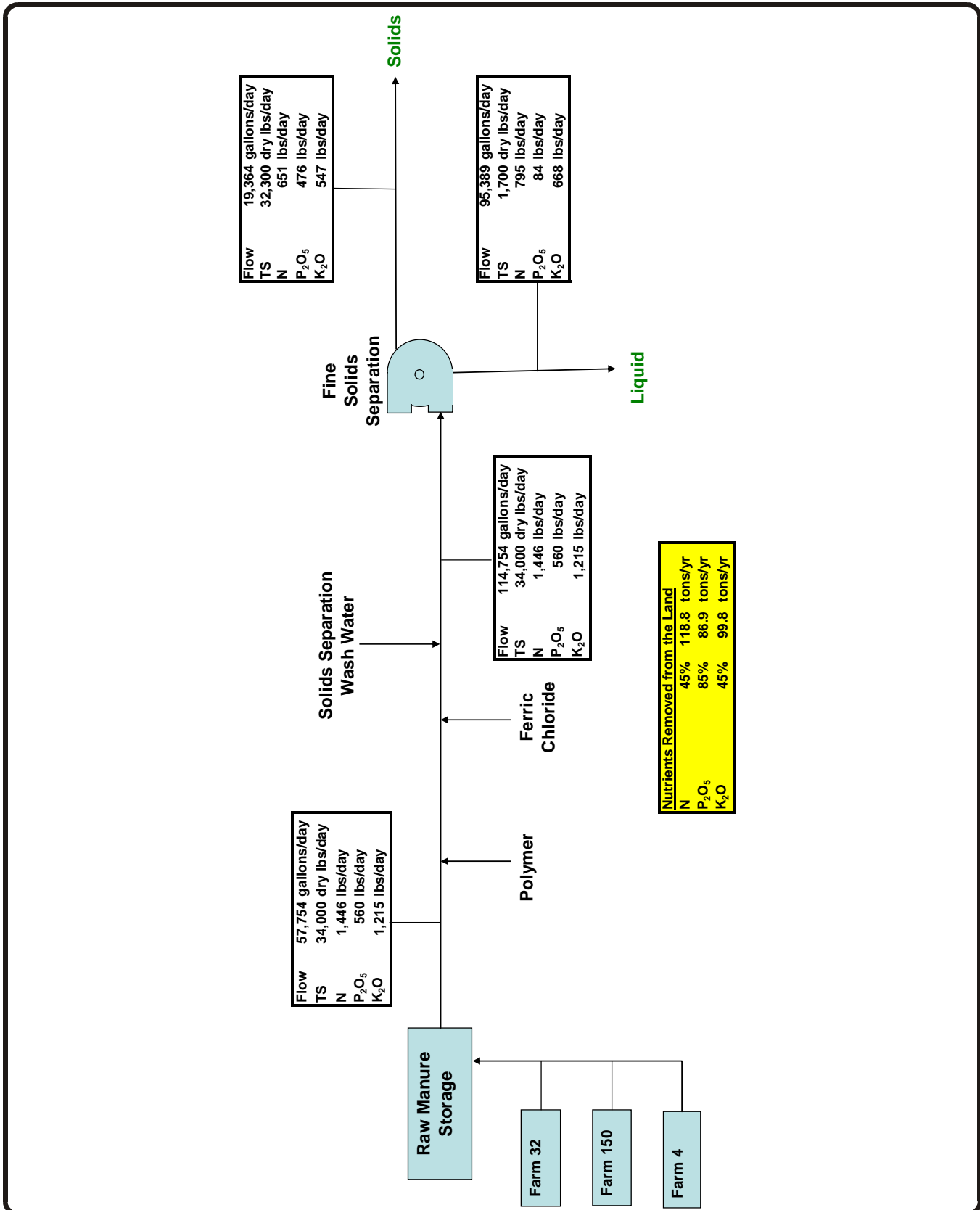

ALTERNATIVE C-2W (WAUNAKEE)
 FINE SOLIDS SEPARATION WITH FERRIC CHLORIDE AND POLYMER ADDITION
 COMMUNITY MANURE MANAGEMENT FEASIBILITY STUDY
 DANE COUNTY, WISCONSIN



FIGURE 4.03-3
 1-124.005

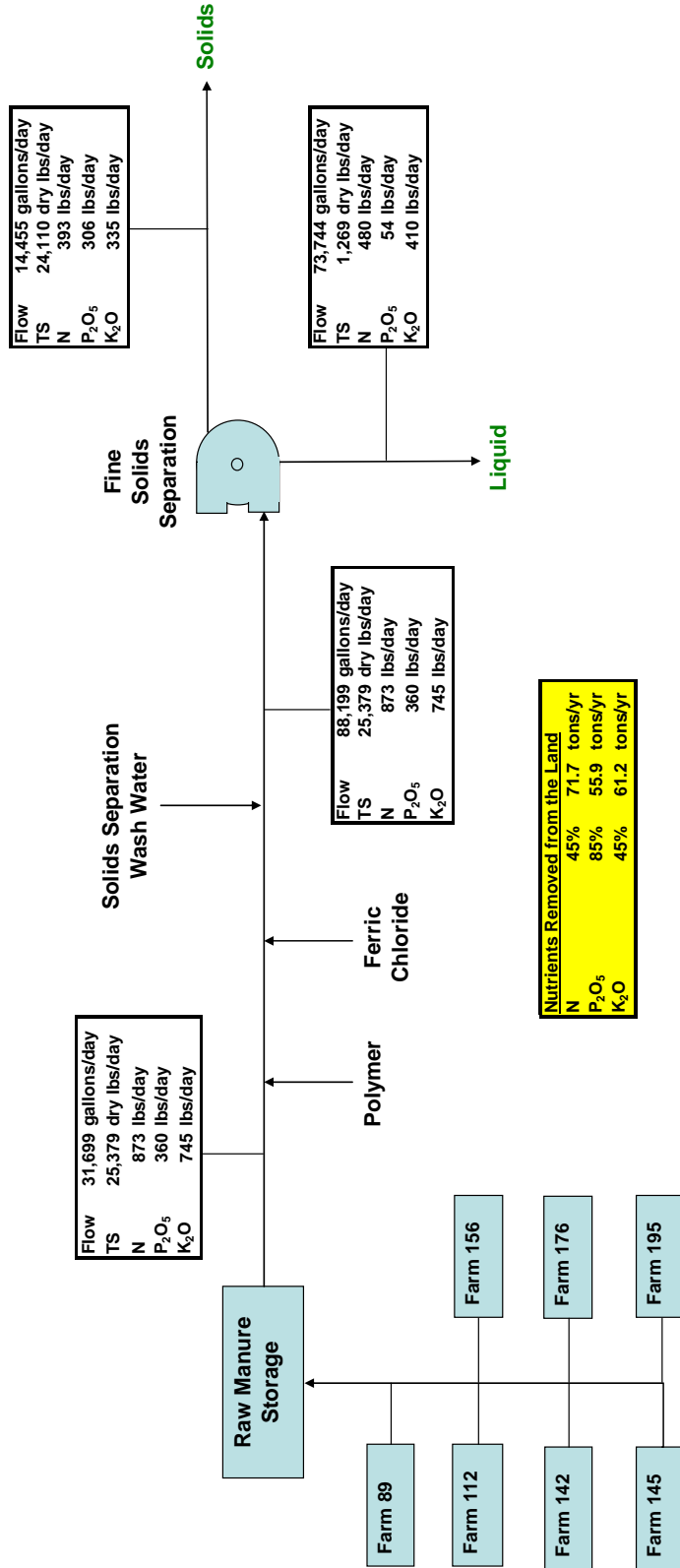

ALTERNATIVE C-2M (MIDDLETON)
 FINE SOLIDS SEPARATION WITH FERRIC CHLORIDE AND POLYMER ADDITION
 COMMUNITY MANURE MANAGEMENT FEASIBILITY STUDY
 DANE COUNTY, WISCONSIN



FIGURE 4.03-4
 1-124.005

The on-site liquid storage lagoon should be sized for one month of storage. Approximately 2.8-million gallons of storage would be necessary for on-site liquid storage at the Waunakee cluster, and about 1.9-million gallons of storage would be necessary for liquids storage in the Middleton cluster. A new structure will be constructed to provide approximately one month of solids storage. The solids can be land-applied, sold to another end user, or composted. Liquids would be spray irrigated by the cluster farms.

Figures 4.03-5 and 4.03-6 present the mass balance through the anaerobic digestion and solids separation process for each cluster. The digestion performance was assumed to be similar to that described for Alternative F-3. The effluent total solids from the digester are projected to be approximately 29,000 dry lbs/day for the Waunakee cluster and 22,000 lbs/day for the Middleton cluster. The total mass of nutrients is expected to be conserved through the digester. Digestion and solids separation performances were developed based on manufacturers' data for system performance. Manufacturers used existing installations to estimate performance for each cluster. Based on these analyses, 85 to 90 percent of the raw manure volume would be conveyed to liquid storage along with the water added for polymer dilution and screen wash water. The liquid portion contains less than 5 percent of the solids, 15 percent of the P, and 55 percent of the N and K for both clusters.

The chemical demands for the Waunakee cluster are about 220 lbs/day of polymer and 1,800 lbs/day of ferric chloride. The system would require approximately 13,000 gallons of polymer makeup water and 25,000 gallons of screen wash water per day. The chemical demands for the Middleton cluster are about 160 lbs/day of polymer and 1,300 lbs/day of ferric chloride. Polymer dilution water and screen wash water are estimated to require approximately 10,000 gpd and 25,000 gpd, respectively. Both systems are designed to operate approximately 40 to 50 hours/week and are estimated to require two full-time staff for operation and maintenance.

E. Alternative C-4: Fine Solids Separation with Ferric Chloride and Polymer Addition Followed by a Dryer/Pelletizer

This alternative includes the entire Alternative C-2 followed by a dryer system to produce a final solids product with a moisture content of about 10 to 15 percent or less. The solids from the solids separation equipment will be transferred to a storage bin that will act as the feed hopper for the dryer. From there, an auger will be used to feed solids into the dryer. The drying process uses three different stages to dehydrate the solids. The different stages are controlled by individual burners and are designed to maximize drying while limiting burning or overheating of the material. The dryer also has a thermal oil heating system and a condenser and off-gassing system. Once the manure has been dried, it will be transferred to final product storage through a discharge/cooling conveyor. Final storage is sized to hold one month of dried material.

The dryer will be operated in a batch mode where separated solids will be collected and stored until the feed hopper is nearly full. Then the dryer will be started and operated until the feed solids supply is depleted. Because of manufacturer's sizing limitations, the dryer at each cluster has

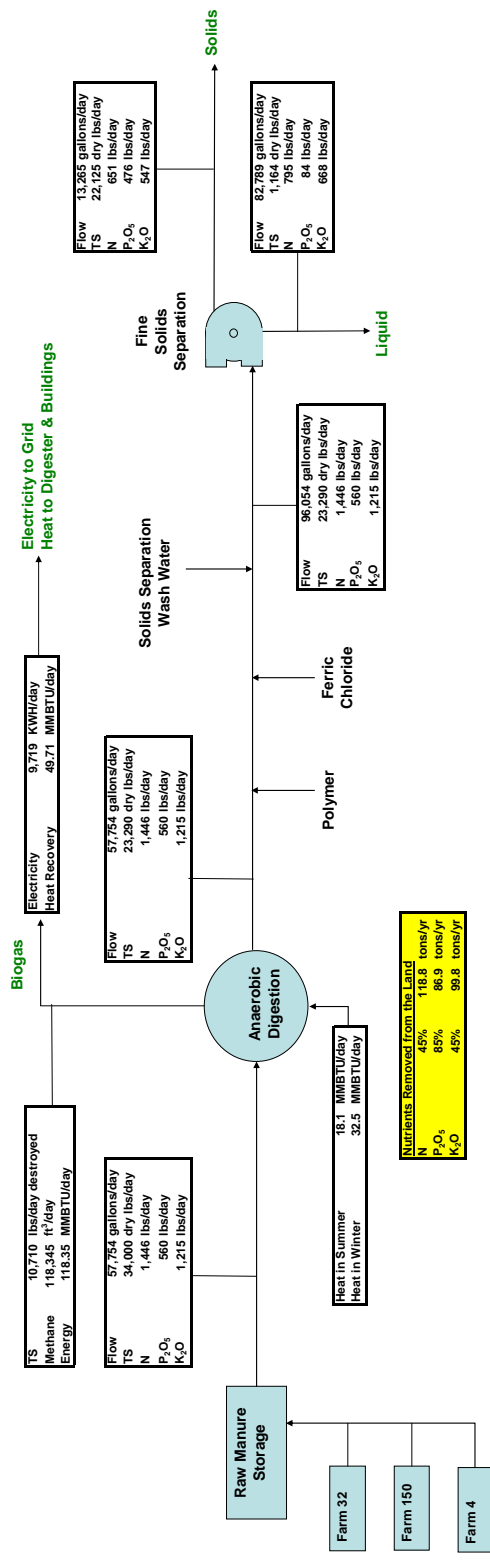

**ALTERNATIVE C-3W (WAUNAKEE)
ANAEROBIC DIGESTION FOLLOWED BY SOLIDS SEPARATION WITH
FERRIC CHLORIDE AND POLYMER ADDITION
COMMUNITY MANURE MANAGEMENT FEASIBILITY STUDY
DANE COUNTY, WISCONSIN**



**FIGURE 4.03-5
1-124.005**

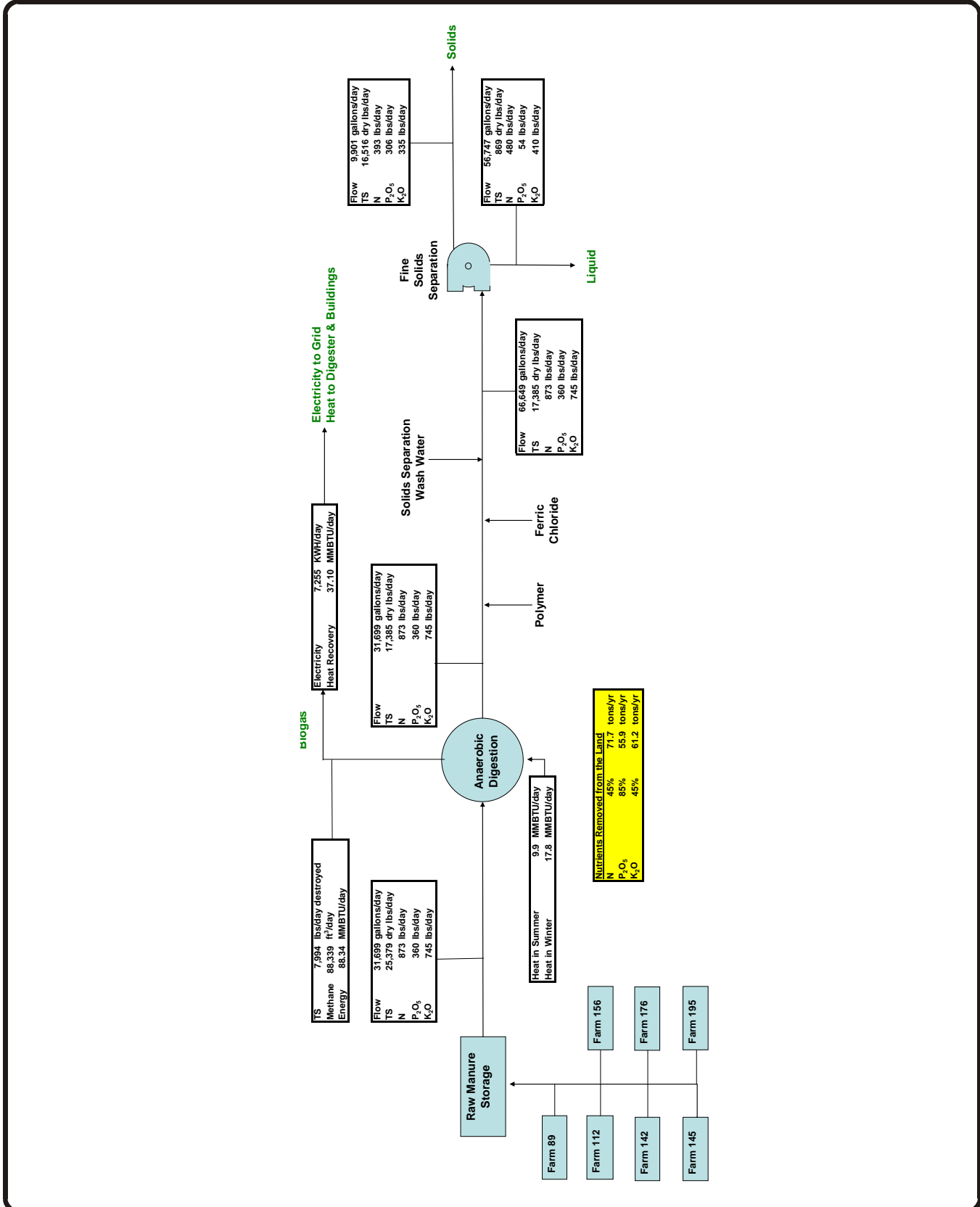

ALTERNATIVE C-3M (MIDDLETON)
ANAEROBIC DIGESTION FOLLOWED BY SOLIDS SEPARATION WITH
FERRIC CHLORIDE AND POLYMER ADDITION
COMMUNITY MANURE MANAGEMENT FEASIBILITY STUDY
DANE COUNTY, WISCONSIN



FIGURE 4.03-6
1-124.005

excess capacity. The dryer would be sized to operate at 80 percent of its capacity for the Waunakee cluster and about 60 percent of its capacity in the Middleton cluster. The efficiency of the system will be maximized when operated at the design solids throughput capacity. Therefore, if this alternative is further evaluated, additional manufacturers should be contacted to determine if the capacity of the dryer can more closely match the design solids throughput.

Figures 4.03-7 and 4.03-8 show the mass balance through the solids separation and drying processes for the two clusters. These balances were generated using manufacturers' estimates for system performance. Approximately 75 to 85 percent of the raw manure volume would be conveyed to liquid storage following the dewatering step along with the water added for polymer dilution and screen wash water. This liquid portion contains less than 5 percent of the solids, 10 percent of the P, and 55 percent of the N and K for both clusters. The solids are dried to approximately 85 to 90 percent dryness. Polymer dilution water and wash water are assumed to add negligible amounts of solids and nutrients.

The chemical demands for the Waunakee cluster are 320 lbs/day of polymer and 2,600 lbs/day of ferric chloride. The system also requires approximately 19,000 gpd of polymer makeup water and 38,000 gpd of screen wash water. The chemical demands for the Middleton cluster are 240 lbs/day of polymer and 1,900 lbs/day of ferric chloride. Estimated water requirements are 15,000 gpd of polymer makeup water and 42,000 gpd of screen wash water. The solids separation systems are designed to operate 40 to 50 hours per week. The dryer will operate approximately 5.6 days per week for the Waunakee cluster and 4.2 days per week for the Middleton cluster. Both systems are anticipated to require two full-time staff for operation and maintenance.

F. Alternative C-5: Manure Combustion

In this alternative, raw manure would be delivered to a raw manure storage tank sized to provide about one week of storage. From there the raw manure would be pumped into a drying vessel that uses recovered heat and mixing to evaporate moisture and achieve relatively dry solids (moisture content is approximately 40 percent). After drying, the manure can be used for bedding or it can continue to the combustion system (boiler). In the boiler, the dried manure is combusted to create steam. The steam is piped to a turbine/generator set and used to generate electricity. Waste steam heat is recovered and used in the upstream drying process.

Figures 4.03-9 and 4.03-10 show the mass balance through the drying and incineration processes for each cluster. These numbers were generated using manufacturers' data for system performance. Manufacturers' used existing installations to estimate future performance.

This system will operate 168 hours per week and will require two full-time staff for operations and maintenance.

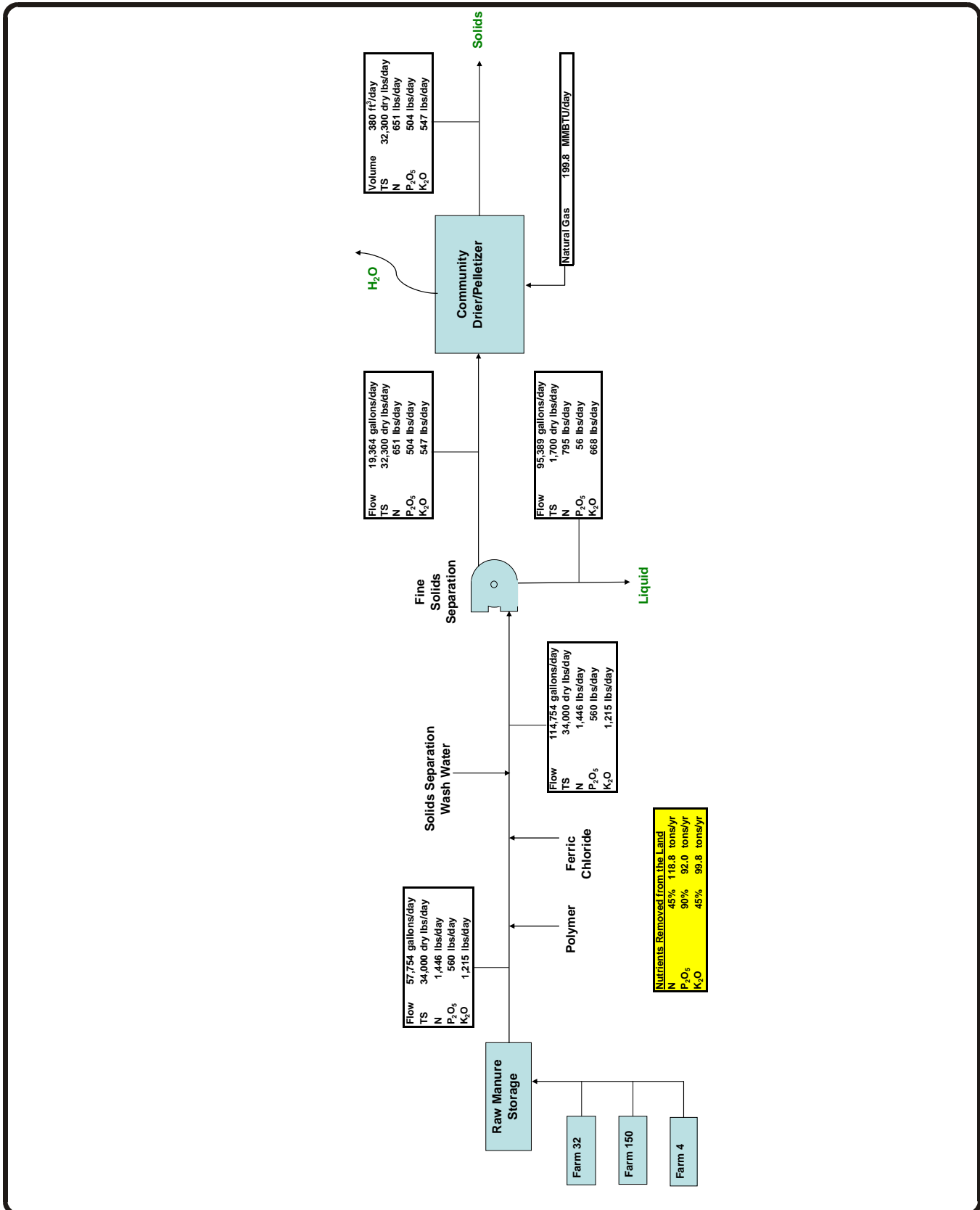

**ALTERNATIVE C-4W (WAUNAKEE)
FINE SOLIDS SEPARATION WITH FERRIC CHLORIDE AND
POLYMER ADDITIONS FOLLOWED BY A DRYER/PELLETIZER
COMMUNITY MANURE MANAGEMENT FEASIBILITY STUDY
DANE COUNTY, WISCONSIN**



**FIGURE 4.03-7
1-124.005**

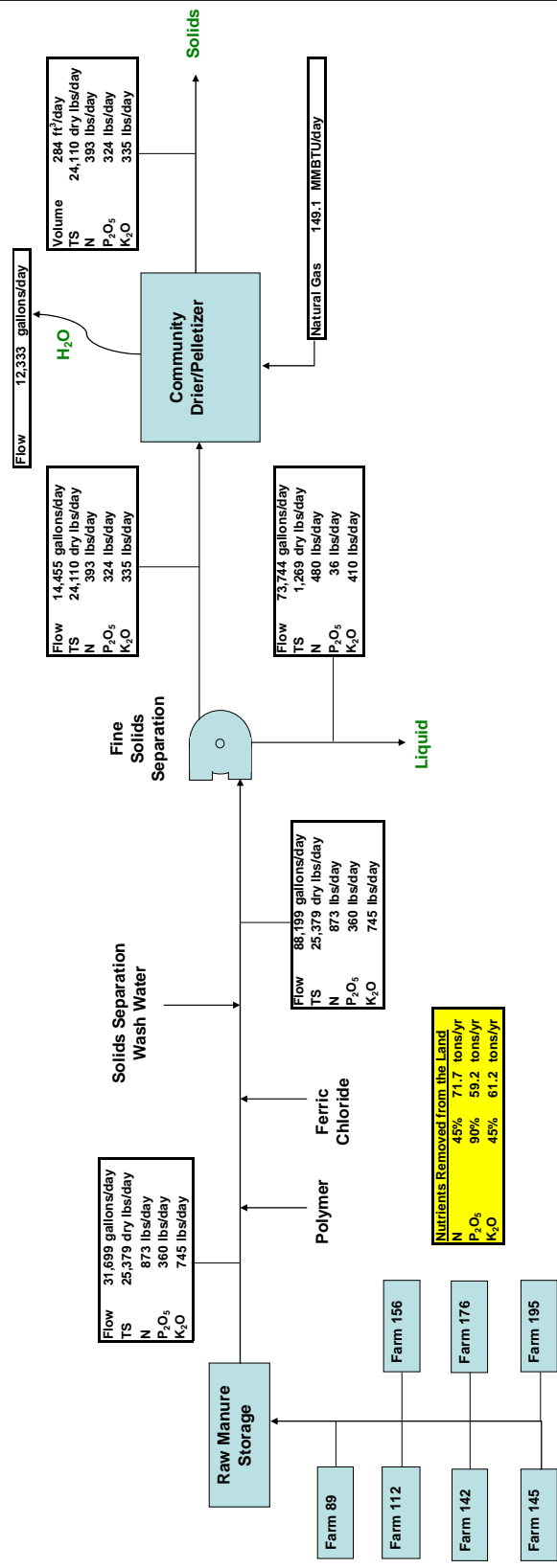

**ALTERNATIVE C-4M (MIDDLETON)
FINE SOLIDS SEPARATION WITH FERRIC CHLORIDE
AND POLYMER ADDITION FOLLOWED BY A DRYER/PELLETIZER
COMMUNITY MANURE MANAGEMENT FEASIBILITY STUDY
DANE COUNTY, WISCONSIN**

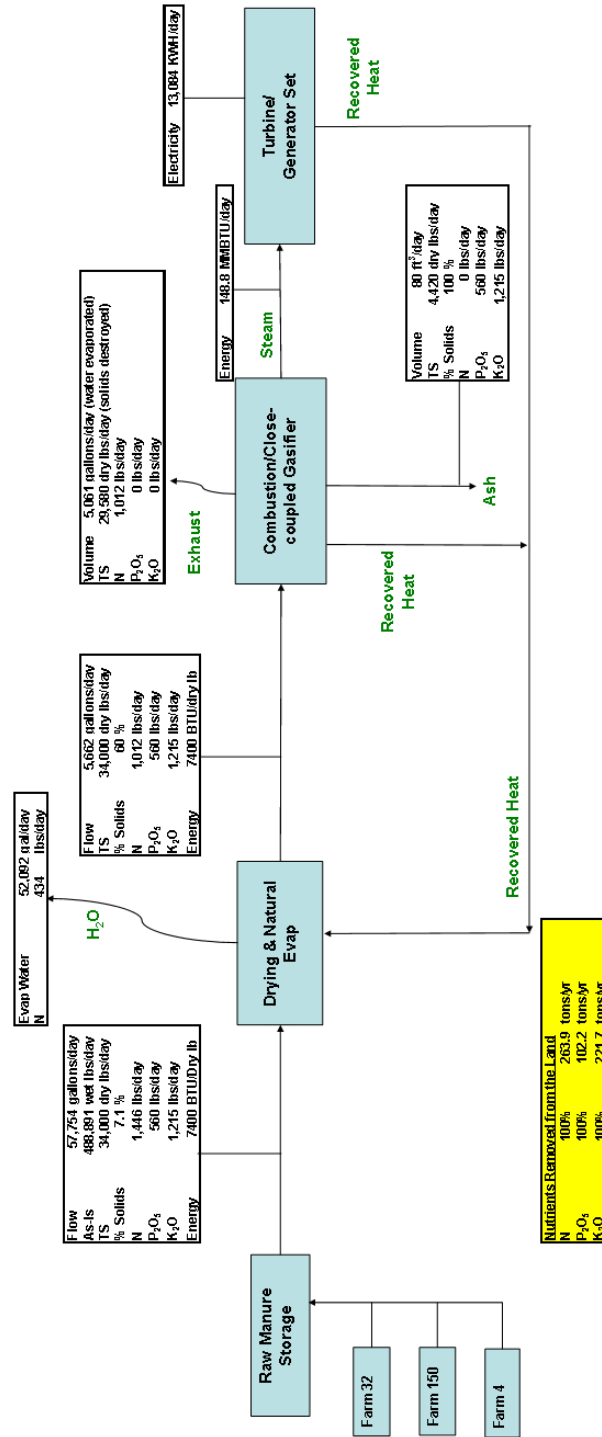

**FIGURE 4.03-8
1-124.005**

ALTERNATIVE C-5W (WAUNAKEE)
 MANURE COMBUSTION
 COMMUNITY MANURE MANAGEMENT FEASIBILITY STUDY
 DANE COUNTY, WISCONSIN



FIGURE 4.03-9
 1-124.005



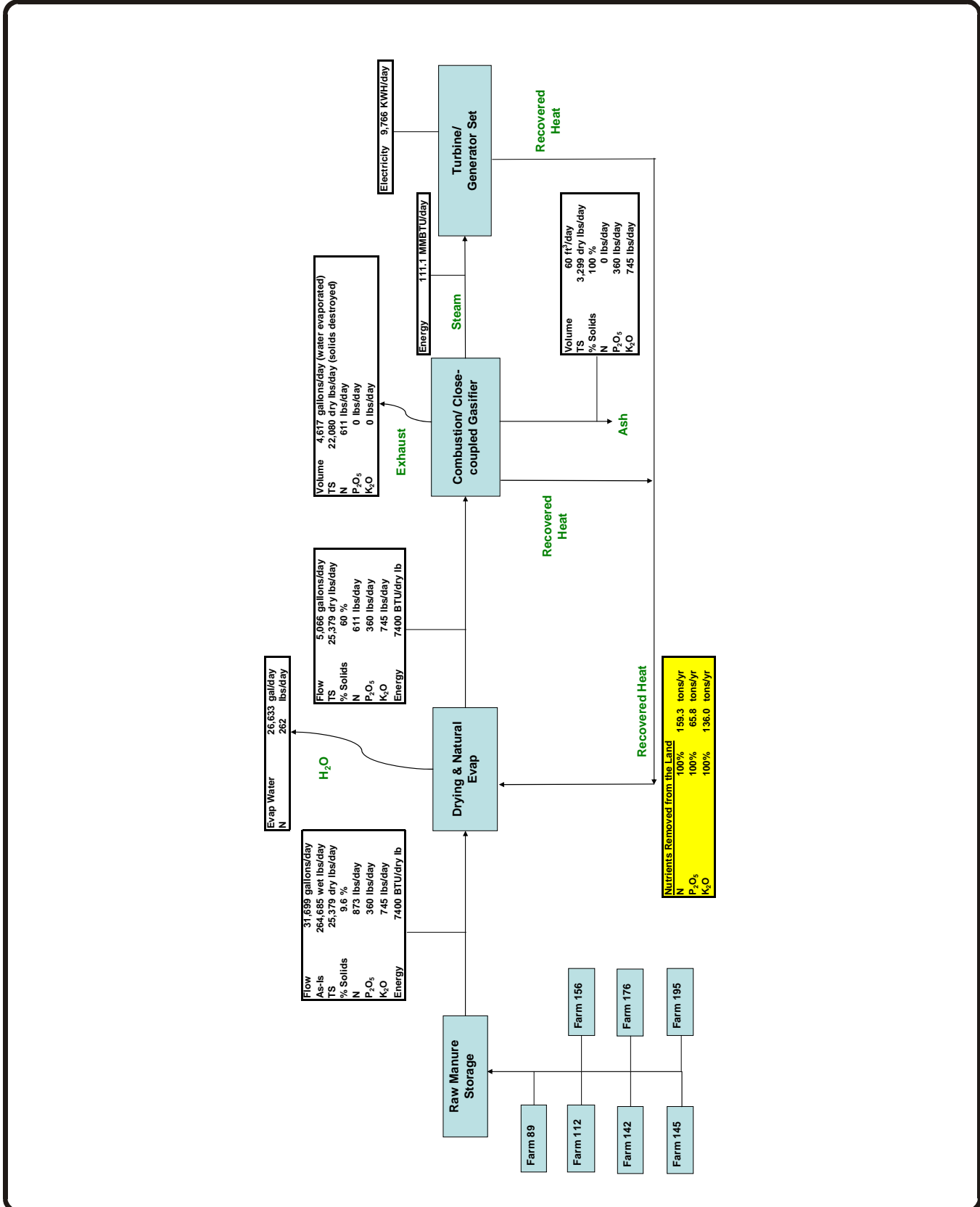

ALTERNATIVE C-5M (MIDDLETON)
 MANURE COMBUSTION
 COMMUNITY MANURE MANAGEMENT FEASIBILITY STUDY
 DANE COUNTY, WISCONSIN



FIGURE 4.03-10
 1-124.005

4.04 OPINION OF CAPITAL COSTS

At this early stage of planning, detailed opinions of capital cost cannot be developed precisely, since the project elements and details have not been considered thoroughly. Based on our experience with similar projects, we used the following procedure to develop opinions of capital cost for the eight management alternatives:

1. Proposals for major equipment were solicited from manure processing equipment manufacturers and vendors. We typically add a 35 percent factor to account for labor, miscellaneous materials, and other unforeseen items required to install the equipment.
2. For some equipment and structures, our past experience with similar projects was relied on to develop costs.
3. Equipment and control building sizes were estimated and assigned a unit cost of \$100/ft².
4. Solids storage facilities were assigned a unit cost of \$25/ft² plus an additional \$350/cy for the concrete slab. Slabs were estimated to be 1 foot thick.
5. Underground piping (force mains) was assigned a unit cost of \$60/LF.
6. Percentages of equipment costs and buildings cost subtotals were used to estimate subcontractor installation costs for piping and mechanical (10 percent), electrical (10 percent), heating and ventilation (5 percent), and site work (5 percent).
7. These percentages are based on past projects and the current construction market.
8. General conditions for the contractor have been estimated at 8 percent of the cost of the equipment, buildings, mechanical, electrical, heating and ventilating, and site work costs. Contingencies at 25 percent and engineering/legal services at 15 percent of the total construction cost were included in the overall capital cost opinion for the eight alternatives.

These assumptions are summarized in Table 4.04-1.

A summary of the opinions of capital cost are included in Table 4.04-2 for all the alternatives. The detailed cost evaluations are included in Appendix C. In general, the capital costs for the Waunakee cluster are greater than those for the Middleton cluster because of the infrastructure required to pump manure to the cluster site. In addition, the volumes of manure are greater in the Waunakee cluster based on the data contained in the farm surveys responses.

On a per animal unit basis, the costs for the larger cluster facilities are considerably lower than the costs at an individual farm. In particular, the capital cost per animal unit for the Middleton Cluster

is approximately one-half the capital cost per A.U. for the individual farm for similar technologies (i.e., comparing Alternative F3 with Alternative C-3M). This is the result of significant economies of scale that would be realized by constructing a cluster facility to serve more than one farm.

Alternative	P Removed (%)	Capital Costs		
		Total	Per Current A.U.	Per Design A.U.
<u>Individual Farm^a</u>				
F-1	45%	\$1,426,000	\$2,850	\$2,130
F-2	85%	\$1,685,000	\$3,370	\$2,510
F-3	85%	\$2,840,000	\$5,680	\$4,240
<u>Waunakee Cluster^b</u>				
C-1W	45%	\$6,423,000	\$2,040	\$1,500
C-2W	85%	\$8,415,000	\$2,680	\$1,960
C-3W	85%	\$11,495,000	\$3,660	\$2,680
C-4W	90%	\$13,507,000	\$4,300	\$3,150
C-5W	100%	\$11,333,000	\$3,600	\$2,640
<u>Middleton Cluster^c</u>				
C-1M	45%	\$5,127,000	\$1,340	\$1,030
C-2M	85%	\$8,215,000	\$2,150	\$1,660
C-3M	85%	\$10,934,000	\$2,870	\$2,210
C-4M	90%	\$13,247,000	\$3,470	\$2,670
C-5M	100%	\$10,319,000	\$2,710	\$2,080

^a Current A.U. = 500; design A.U. = 669.
^b Current A.U. = 3,145; design A.U. = 4,293.
^c Current A.U. = 3,813; design A.U. = 4,957.
^d the opinion of costs are considered +/- 25 percent at this time.

Table 4.04-2 Opinion of Capital Cost Summary^d

4.05 OPINION OF OPERATION AND MAINTENANCE (O&M) COSTS

O&M costs include the costs or revenues anticipated to occur on a regular, on-going basis. Opinions of annual O&M costs were developed for three scenarios: (1) Year 2007 condition with the existing herd sizes, (2) Year 2012 conditions including the anticipated growth of the herds, and (3) Year 2012 conditions including the anticipated growth and the 25 percent allowance for additional manure or industrial waste loadings to the facility. The design basis for the individual farm, Waunakee Cluster, and Middleton Cluster included 535 A.U., 3,434 A.U., and 3,966 A.U., respectively.

Table 4.05-1 presents a summary of the unit costs we have included in these evaluations. Most of the O&M cost categories were inflated by 2.5 percent annually to derive the year 2012 O&M costs. The

exception to this is the GHG reduction credit and associated revenue stream, which are expected to increase at a rate faster than inflation. Projections from the Carbon Solution Group™ were applied to the potential GHG emission reduction credits in 2007 and 2012. Detailed O&M costs for all alternatives are presented in Appendix C.

The following discussion presents some of the assumptions and background information for each of the O&M cost categories.

Labor was estimated on a full-time equivalent (FTE) basis at a rate of \$40/hour, which includes fringe benefits. Operators are expected to be knowledgeable about mechanical systems and treatment process environments. It is expected that they will be familiar with chemical feed systems and working in hazardous environments.

Category	Unit O&M Cost	
	(2007)	(2012) ¹
Labor (per hour)	\$ 40	\$45
Electricity (per KWH)	\$0.10	\$0.11
Electricity Buy-Back Rate (per KWH) ²	\$0.065	\$0.070
Natural Gas (per therm)	\$1.00	\$1.13
Solids Value (per wet ton)		
Alt. F-1, C-1	\$5	\$6
Alt. F-2, C-2	\$10	\$11
Alt. F-3, C-3	\$20	\$23
Alt. C-4, C-5	\$50	\$57
Renewable Energy Certificates (per KWH) ²	Included above ²	
GHG Emission Reductions Credit (per MtCO ₂ e) ³	\$6	\$12
Polymer (per pound)	\$1.50	\$1.70
Ferric Chloride (per gallon)	\$1.00	\$1.13
Maintenance and Supplies ⁴ (% of equipment costs)	2.0	2.3
Land Rental (per acre/year)	\$140	\$158

¹ Year 2012 costs assumed to increase at the rate of inflation (2.5 percent/year) except for GHG emission reductions and RECs.
² The electrical buy-back rate includes RECs associated with the electrical generation from biogas.
³ MtCO₂e = metric ton of CO₂ equivalent; 1 metric ton ~ 2,200 lbs.
⁴ Maintenance costs estimated by manufacturers were used in lieu of percentages when provided.

Table 4.05-1 O&M Unit Costs (2007)

Electricity and natural gas usage was estimated based on manufacturers' information and horsepower operating hours. Unit costs for electricity and natural gas are an approximate average rate in Dane County at this time. An energy credit was applied where alternatives would generate excess energy. The credit assumes the excess energy would be used to generate electricity (Alternatives F-3, C-3, and C-5), and any electricity generated beyond that needed on-site would be purchased by the local power utility at an average buy-back price of \$0.065/kWh based on current rates. This buy-back rate is based on one utility company's existing program in Wisconsin, in which the utility purchases electricity and associated renewable energy credits generated by anaerobic digesters owned by its Wisconsin customers. Under a 10-year contract, customers receive \$0.08/ kWh for electricity generated on-peak (9 A.M. to 9 A.M.) and \$0.049/ kWh for electricity generated off-peak (9 P.M. to 9 A.M.). Assuming relatively uniform biogas generation throughout a typical day, the average buy-back rate is approximately \$0.065/ kWh.

In lieu of electrical generation, the excess energy could be in the form of excess biogas produced at a manure digestion facility (Alternatives F-3 and C-3). The excess biogas could be cleaned to near natural gas quality and injected directly into a natural gas pipeline, or the biogas could be used by a nearby industry to supplement natural gas usage (e.g., used in a boiler). This latter potential may especially be feasible for the Middleton Cluster because of its location. However, this use was not considered in these analyses.

There are at least a few examples of cleaning manure-based biogas to natural-gas grade quality. The Scenic View Dairy in Fennville, Michigan, was started up in 2007 and digests manure from approximately 2,000 dairy cattle (2,800 A.U.). The excess methane generated may be used on-site or injected into a natural gas pipeline. A similar, but larger facility in Texas was installed to produce pipeline-grade natural gas from biogas generated from anaerobic digestion of manure from up to 10,000 cows.

Solids management is one of the most significant O&M cost variables in these analyses since the value of the final solids products will likely vary considerably as a function of the management alternative, the location, and the market for the solids at any given time. Potential disposal markets include composting operations, supplement for wood processing/fiberboard, use as a soil amendment and/or fertilizer, and potting soil replacement among others. None of these markets are well developed at this time. However, based on our discussions with researchers (Forest Products Laboratory, UW-Platteville) and entities engaged in these markets, we understand that the high-end value of the solids produced from anaerobic digestion (Alternatives F-3 and C-3) is about \$30/ton at this time. Alternatives F-1 and C-1, as well as F-2 and C-2, would have lower market value on average because of the potential for disease organisms, the poorer consistency in fiber characteristics, and the potential odors from such material. In addition, based on a manure management operation in southeast Wisconsin, we believe the market for dried manure may be as high as \$80 or \$90 per ton. The values used in these analyses are lower than the values cited herein to provide a measure of conservatism. However, we have also included a sensitivity analysis as a function of the value of the solids generated in manure management alternatives later in this chapter.

GHG emission reduction credits are based on the estimated mass of GHG emissions eliminated with each alternative compared to the existing method of lagoon storage and land application. The inherent assumption in this determination is that, within the storage lagoons, anaerobic conditions generate methane gas, which is released to the atmosphere. The amount of methane production expected from lagoon storage is based on the site location—in northern climates, the average temperature is lower and the amount of biological activity in the lagoon decreases, resulting in lower methane production. Therefore, the GHG credits are typically lower in northern climates as compared to a similar facility located in the south. By implementing alternate manure management systems, some or all of the organic material will not be stored for long periods of time, and, therefore, methane emissions will be reduced.

For Alternatives F-3, C-3, and C-5, in which either biogas or manure is combusted to produce energy, CO₂ and other GHGs may be given off in excess of the levels that would have been emitted from storage lagoons. However, the GHG emissions from a lagoon are considered biogenic (produced by natural life processes, including the natural processes inherent to plants and animals) as opposed to anthropogenic (derived from human activities). Therefore, the emissions associated with the combustion of the biogas captured (or from the manure itself) do not count as increased GHG emissions. This is because the feedstocks in the manure are natural carbon sequesters, and in a natural aerobic environment where the material is allowed to decay, these emissions would have occurred naturally (biogenically). Therefore, combusting the biogas does not result in anthropogenic emissions such as would occur with the combustion of fossil fuels.

GHG emission reduction credits included in these analyses are based on preliminary estimates from the Carbon Solution GroupTM. The estimated GHG emission reduction from a 5,000-A.U. anaerobic digestion system was estimated at approximately 18,500 MtCO₂e/year. For the purposes of this evaluation, we have developed approximate GHG emission reductions for the alternatives based on solids eliminated from long-term lagoon storage (Table 4.05-2).

Renewable energy certificates (RECs) are included in the electrical buy-back cost noted above and in Table 4.05-1. The value of RECs is expected to vary significantly and generally increase over time. Based on recent information, the current value of RECs is in the range of \$0.004 to \$0.005/ kWh, or approximately 5 to 10 percent of the buy-back value of electricity.

Chemical cost opinions were developed based on manufacturers' estimates and our experience with polymer and ferric chloride in wastewater treatment applications. Maintenance and supply costs were estimated at 2 percent of the equipment costs or as specified by the manufacturer.

Raw manure hauling and liquid disposal costs were estimated for the Middleton Cluster using the *Professional Nutrient Applicators of Wisconsin Truck Haul Job Estimator* spreadsheet. Trips were assumed to be two-way hauling trips with raw manure being hauled to the cluster and finished liquids being hauled back to the farm for as many trips as possible. In all cases the volume of finished liquids exceeds raw manure, which required additional one-way trips to haul finished liquids to the farms. Raw manure and finished liquids will be pumped in the Waunakee Cluster. The costs for pumping are accounted for in the equipment costs and the power costs. It was assumed that farmers will own enough land for spray irrigation of liquid residuals.

The current O&M costs for the individual farms and the cluster farms were developed for comparison by using data reported in the survey for each of the cluster farms extrapolated to the design A.U. size. The cluster data was used to estimate the individual farm costs using average costs per A.U. The current operating costs generally consist of three elements, labor, hauling, and land rental, as discussed here:

1. Labor costs were estimated using the reported time from each farm for hauling manure, applying manure, and maintaining manure-related equipment and labor cost of \$40 per hour.
2. Hauling costs were estimated using the *Truck Haul Job Estimator* spreadsheet. Half of the average maximum hauling distance for the cluster was used as the hauling distance.

Alternative	Solids Removed (% of Existing)	GHG Emission Reduction ^a (MtCO ₂ e/year)
Individual Farms (535 A.U., 1.7 dry tons/day)		
F-1	45	890
F-2	95	1,880
F-3 ^b	100	1,980
Waunakee Cluster (3,434 A.U., 17 dry tons/day)		
C-1W	45	8,900
C-2W	95	18,800
C-3W ^b	100	19,800
C-4W ^c	100	15,000
C-5W	100	19,800
Middleton Cluster (4,000 A.U., 12.7 dry tons/day)		
C-1M	45	6,650
C-2M	95	14,000
C-3M ^b	100	14,800
C-4M ^c	100	11,900
C-5M	100	14,800

^a Based on 18,500 MtCo₂e/year reduction from a 5,000-A.U. anaerobic digestion facility designed to handle 15.9 dry tons/day of solids (Carbon Solutions Group™). GHG generation from vehicular fuel and operating power are not included as these values are minor compared to the GHG reductions. Results are preliminary and subject to a more detailed investigation.

^b Assumed solids in liquid are nonbiodegradable.

^c Natural gas used in the drying process estimated at 199.8 MMBTU/day for the Waunakee Cluster and 149.1 MMBTU/day for the Middleton Cluster. GHG equivalent of natural gas ~ 117 lbs CO₂/MMBTU.

Table 4.05-2 GHG Emission Reductions

- Land rental costs were estimated using reported acres rented that manure is spread on at an annual cost of \$140/acre.

Table 4.05-3 presents our opinion of annual O&M costs for the existing individual farms, existing farm clusters, and each of the manure management alternatives. The O&M costs are presented in the current year (2007) as well as in the year 2012. Appendix C presents more detailed opinions of O&M costs for all of the alternatives evaluated.

Alternative	P Removed (%)	Opinion of Net Annual O&M Expense (Revenue)			
		Year 2007	Year 2012	Year 2012 + 25% (design A.U.)	Per A.U. (2007)
Individual Farm^a					
Existing	0%	\$82,000	\$93,000	\$107,000	\$164
F-1	45%	\$152,000	\$165,000	\$193,000	\$304
F-2	85%	\$53,000	\$47,000	\$48,000	\$106
F-3	85%	\$82,000	\$78,000	\$80,000	\$174
Waunakee Cluster^b					
Existing	0%	\$936,000	\$1,059,000	\$1,218,000	\$298
C-1W	45%	\$1,007,000	\$1,086,000	\$1,291,000	\$320
C-2W	85%	\$98,000	\$20,000	(\$13,000)	\$30
C-3W	85%	(\$220,000)	(\$350,000)	(\$480,000)	(\$68)
C-4W	90%	\$884,000	\$890,000	\$1,072,000	\$281
C-5W	100%	(\$183,000)	(\$296,000)	(\$409,000)	(\$73)
Middleton Cluster^c					
Existing	0%	\$682,000	\$772,000	\$926,000	\$179
C-1M	45%	\$946,000	\$1,031,000	\$1,222,000	\$248
C-2M	85%	\$600,000	\$612,000	\$701,000	\$156
C-3M	85%	\$304,000	\$268,000	\$271,000	\$82
C-4M	90%	\$1,144,000	\$1,210,000	\$1,451,000	\$300
C-5M	100%	\$235,000	\$199,000	\$193,000	\$51

^a Year 2007 A.U. = 500; Year 2012 A.U. = 535; design A.U. = 669.
^b Year 2007 A.U. = 3,145; Year 2012 A.U. = 3,434; design A.U. = 4,293.
^c Year 2007 A.U. = 3,813; Year 2012 A.U. = 3,966; design A.U. = 4,957.
^d O&M costs do not include the cost for any commercial fertilizer required to replace manure-based fertilizer not applied to the soil in any of the alternatives.

Table 4.05-3 Opinion of Annual O&M Costs^d

The annual O&M cost opinions developed in Table 4.05-3 should not be considered to be precise costs, as they are derived from a number of assumptions, simplifications, and data provided by vendors, farmer surveys, and our past experience. However, on a comparative basis several significant observations are noted:

1. For the individual farm alternatives, only Alternative F-2–Fine solids removal with polymer and ferric addition appears to lower annual O&M costs significantly compared to the existing O&M cost opinions.
2. For the cluster alternatives, the Waunakee Cluster appears to have significantly lower annual O&M costs than the Middleton Cluster. This is mainly because in the Waunakee Cluster, manure and returned liquids are pumped to and from the cluster site, whereas in the Middleton Cluster the manure and returned liquids are transported by truck.
3. For the Waunakee Cluster, all of the alternatives except C-1W (solids separation) and C-4W (drying) are anticipated to lower annual O&M costs significantly compared to the existing farms' O&M costs. The reason that Alternative C-1W is not anticipated to lower annual O&M costs for the farms in that cluster is that, because of the relatively lower solids and phosphorus removal achieved by this technology, the nutrient level of the liquids returned to the farms will still require trucking to the land, which has a higher O&M cost than pumping to land application fields. Alternative C-4W has a high annual cost for natural gas.
4. For the Waunakee Cluster, the options that include energy recovery (Alternatives C-3W and C-5W) appear to generate net revenue. That is, the preliminary estimate of revenue streams (sale of solids, electricity buy-back, and GHG emission reduction credits) exceed the annual costs to operate the facilities. In addition, as the amount of manure handled increases, the net revenue appears to increase.
5. For the Middleton Cluster, only the alternatives with energy recovery (Alternatives C-3M and C-5M) appear to lower annual O&M costs to a significant degree compared to the existing farms' collective O&M costs.
6. For the anaerobic digestion (C-3W) and combustion (C-5W) alternatives for the Waunakee Cluster, the amount of electrical generation potential is approximately 9,700 kWh/day and 13,100 kWh/day, respectively. This is equivalent to the amount of power used by approximately 415 and 560 homes, respectively, with an average energy use of 700 kWh/month.
7. Similarly, for the Middleton Cluster Alternatives C-3M and C-5M, the amount of electrical generation potential is approximately 7,300 kWh/day and 9,800 kWh/day,

respectively, which is equivalent to the amount of power used by approximately 313 and 420 homes, respectively.

8. On a preliminary basis, the potential GHG emissions reduction from eliminating long-term lagoon storage of the manure is estimated at approximately 19,800 metric tons/year of equivalent CO₂ for Alternatives C-3W and C-5W (Table 4.05-2). This is approximately equivalent to:
 - The CO₂ emissions from the annual electrical generation to supply 3,800 homes using 700 kWh/month of electricity (1 kWh of electricity ~ 1.37 lbs CO₂).
 - The CO₂ emissions from the annual natural gas use of 3,900 homes using 80 therms of natural gas/month (1 MMBTU of natural gas ~ 117 lbs CO₂).
 - The CO₂ emissions from driving approximately 50-million miles/year at an average fuel economy of 25 miles/gallon (1 gallon of gasoline ~ 21.7 lbs CO₂).
9. For each of the alternatives, the cost of supplying commercial or other fertilizer to replace the manure-based fertilizer was not included as these costs will vary significantly based on the soil needs, crops planted, available land at each farm and amount of land required to be rented, and similar factors. Such an analysis is beyond the scope of this report. However, it is noted that the cost of commercial fertilizer has increased by 40 to 75 percent from a year ago, which is in large part due to significant increases in natural gas prices and transportation costs. Recent commercial fertilizer values are reported as \$0.50/lb of N, \$0.40/lb of P, and \$0.33/lb of K. At these costs, the added cost to purchase commercial fertilizer could increase the overall O&M costs of the manure management alternatives, and in some cases, the cost increase could be significant.

4.06 ANNUAL O&M SENSITIVITY ANALYSES

Several factors have a major impact on the annual cost to operate manure management facilities. However, a few of the O&M categories could have a major impact on the viability of the manure management alternatives evaluated herein because of the uncertainty of such costs over time. For example, while labor costs are a significant component of the annual O&M cost for a facility, labor costs are relatively simple to project over time. However, the value of the residual solids from a manure management facility could and would vary significantly as markets are developed for such materials. The following paragraphs present sensitivity analyses for the following O&M categories, which were selected specifically because the projection of such costs into the future is relatively uncertain: manure/returned liquids hauling costs, solids disposal revenue, and GHG emission reduction credits. The base conditions for the sensitivity analyses were 2007 conditions and unit

costs. Tables 4.06-1, 4.06-2, and 4.06-3 present summaries of these analyses for the individual farm alternatives, Waunakee Cluster alternatives, and the Middleton Cluster alternatives.

A. Liquid Disposal/Manure Trucking

Manure hauling and returned liquid hauling costs are the most significant annual cost item for several of the alternatives, especially for the Middleton Cluster alternatives. These costs are dependent on labor and fuel costs, as well as the cost for land rental, truck maintenance, and related expenses. For this sensitivity analysis, we have calculated the total unit cost for trucking manure and returned liquids as a function of raw manure quantities only for each alternative. This results in a cost per volume of raw manure trucked and is in the range of \$0.026 to \$0.048 per gallon of raw manure for the various alternatives.

Since each alternative has varying unit costs for hauling manure (and return liquids), the sensitivity analyses varied this unit cost from 50 percent to 150 percent of the calculated unit cost (100 percent = value calculated for Table 4.05-3).

As noted previously, the management systems would be designed with a capacity of approximately 25 percent larger than required for the anticipated growth of the farm(s) being served by the system. This provides the potential of hauling additional manure from other farms to the manure management facility. The cost of hauling this additional manure cannot be determined or even estimated within reason since it is dependent on the location of the farm, quantity of manure hauled, regularity of manure hauling, and other factors. For that purpose, unit costs for such additional hauling was not included herein.

B. Solids Disposal Revenue

The value of the final solids products could vary considerably as markets develop for these materials. As noted previously, we have assumed the value of the solids is dependent on the alternative management system. We assigned a base value of \$5/wet ton for alternatives F1 and C-1; \$10/wet ton for Alternatives F-2 and C-2 (higher nutrient content), \$20/wet ton for Alternatives F-3 and C-3 (fewer concerns with disease organisms), and \$50/wet ton for Alternatives C-4 and C-5 (concentration nutrients and improved transportability). For the sensitivity analyses, we allowed the value for each alternative to range from a net cost of \$5/wet ton to dispose of the material (no net value) to a high end value of triple the base value used in Table 4.05-3.

C. GHG Emission Reduction Credits

The value of GHG emission reduction credits will likely increase over time and has the potential of significantly increasing. However, there will potentially be restrictions on the level of credits available as the result of carbon market policies. For example, in some countries, limits may be placed on entities so that only a certain percentage of GHG reduction goals for a given entity may be allowable through purchase on the carbon market, with the remaining GHG reduction required

TABLE 4.06-1

INDIVIDUAL FARMS–O&M COST SENSITIVITY ANALYSES

	Annual O&M Cost (Revenue)		
	Alt. F-1	Alt. F-2	Alt. F-3
Base Annual O&M Cost (Revenue)	\$152,000	\$53,000	\$ 82,000
<u>Manure and Liquid Hauling Sensitivity Analyses</u>			
Base Condition (unit cost/gallon)	\$ 0.046	NA	NA
50% of current cost	\$119,000	\$53,000	\$ 82,000
75% of current cost	\$135,000	\$53,000	\$ 82,000
100% of current cost (base condition)	\$152,000	\$53,000	\$ 82,000
125% of current cost	\$169,000	\$53,000	\$ 82,000
150% of current cost	\$186,000	\$53,000	\$ 82,000
<u>Solids Disposal Revenue Sensitivity Analyses</u>			
Base Condition (unit value /wet ton)	\$ 5.00	\$ 10.00	\$ 20.00
\$5/ton cost of disposal	\$166,000	\$95,000	\$130,000
\$0/ton	\$159,000	\$81,000	\$120,000
base value condition (see above)	\$152,000	\$53,000	\$ 82,000
twice base value	\$145,000	\$25,000	\$ 44,000
triple base value	\$138,000	(\$3,000)	\$ 6,000
<u>GHG Emission Reduction Credit Sensitivity Analyses</u>			
Base Condition (unit value/MtCO ₂ e)	\$ 6.00	\$ 6.00	\$ 6.00
\$3/MtCO ₂ e	\$155,000	\$59,000	\$ 88,000
\$6/MtCO₂e (base condition)	\$152,000	\$53,000	\$ 82,000
\$10/MtCO ₂ e	\$149,000	\$46,000	\$ 74,000
\$15/MtCO ₂ e	\$145,000	\$37,000	\$ 64,000
\$20/MtCO ₂ e	\$140,000	\$27,000	\$ 54,000

TABLE 4.06-2

WAUNAKEE CLUSTER–O&M COST SENSITIVITY ANALYSES

	Annual O&M Cost (Revenue)				
	Alt. C-1W	Alt. C-2W	Alt. C-3W	Alt. C-4W	Alt. C-5W
Base Annual O&M Cost (Revenue)	\$1,007,000	\$ 98,000	(\$220,000)	\$438,000	(\$183,000)
<u>Manure and Liquid Hauling Sensitivity Analyses</u>					
Base Condition (unit cost/gallon)	\$ 0.026	NA	NA	NA	NA
50% of current cost	\$ 729,000	\$ 98,000	(\$220,000)	\$438,000	(\$183,000)
75% of current cost	\$ 868,000	\$ 98,000	(\$220,000)	\$438,000	(\$183,000)
100% of current cost (base condition)	\$1,007,000	\$ 98,000	(\$220,000)	\$438,000	(\$183,000)
125% of current cost	\$1,146,000	\$ 98,000	(\$220,000)	\$438,000	(\$183,000)
150% of current cost	\$1,286,000	\$ 98,000	(\$220,000)	\$438,000	(\$183,000)
<u>Solids Disposal Revenue Sensitivity Analyses</u>					
Base Condition (unit value/wet ton)	\$ 5.00	\$ 10.00	\$ 20.00	\$ 50.00	\$ 50.00
\$5/ton cost of disposal	\$1,141,000	\$ 523,000	(\$ 71,000)	\$569,000	(\$152,000)
\$0/ton	\$1,074,000	\$ 381,000	(\$101,000)	\$557,000	(\$155,000)
base value condition (see above)	\$1,007,000	\$ 98,000	(\$220,000)	\$438,000	(\$183,000)
twice base value	\$ 940,000	(\$185,000)	(\$339,000)	\$319,000	(\$211,000)
triple base value	\$ 873,000	(\$468,000)	(\$458,000)	\$200,000	(\$239,000)
<u>GHG Emission Reduction Credit Sensitivity Analyses</u>					
Base Condition (unit value/MtCO ₂ e)	\$ 6.00	\$ 6.00	\$ 6.00	\$ 6.00	\$ 6.00
\$3/MtCO ₂ e	\$1,034,000	\$ 155,000	(\$161,000)	\$498,000	(\$124,000)
\$6/MtCO ₂ e (base condition)	\$1,007,000	\$ 98,000	(\$220,000)	\$438,000	(\$183,000)
\$10/MtCO ₂ e	\$ 972,000	\$ 23,000	(\$299,000)	\$359,000	(\$262,000)
\$15/MtCO ₂ e	\$ 928,000	(\$ 72,000)	(\$399,000)	\$260,000	(\$362,000)
\$20/MtCO ₂ e	\$ 883,000	(\$166,000)	(\$498,000)	\$160,000	(\$461,000)

TABLE 4.06-3

MIDDLETON CLUSTER–O&M COST SENSITIVITY ANALYSES

	Annual O&M Cost (Revenue)				
	Alt. C-1M	Alt. C-2M	Alt. C-3M	Alt. C-4M	Alt. C-5M
Base Annual O&M Cost (Revenue)	\$946,000	\$600,000	\$304,000	\$812,000	\$235,000
Manure and Liquid Hauling Sensitivity Analyses					
Base Condition (unit cost/gallon)	\$ 0.048	\$ 0.040	\$ 0.034	\$ 0.040	\$ 0.026
50% of current cost	\$ 667,000	\$371,000	\$106,000	\$ 583,000	\$ 82,000
75% of current cost	\$ 807,000	\$485,000	\$205,000	\$ 697,000	\$159,000
100% of current cost (base condition)	\$ 946,000	\$600,000	\$304,000	\$ 812,000	\$235,000
125% of current cost	\$1,086,000	\$715,000	\$403,000	\$ 927,000	\$312,000
150% of current cost	\$1,225,000	\$830,000	\$502,000	\$1,042,000	\$388,000
Solids Disposal Revenue Sensitivity Analyses					
Base Condition (unit value/wet ton)	\$ 5.00	\$ 10.00	\$ 20.00	\$ 50.00	\$ 50.00
\$5/ton cost of disposal	\$1,046,000	\$918,000	\$415,000	\$910,000	\$258,000
\$0/ton	\$ 996,000	\$812,000	\$393,000	\$901,000	\$256,000
base value condition (see above)	\$ 946,000	\$600,000	\$304,000	\$812,000	\$235,000
twice base value	\$ 896,000	\$388,000	\$215,000	\$723,000	\$214,000
triple base value	\$ 846,000	\$176,000	\$126,000	\$634,000	\$193,000
GHG Emission Reduction Credit Sensitivity Analyses					
Base Condition (unit value/MtCO ₂ e)	\$ 6.00	\$ 6.00	\$ 6.00	\$ 6.00	\$ 6.00
\$3/MtCO ₂ e	\$966,000	\$642,000	\$349,000	\$857,000	\$280,000
\$6/MtCO₂e (base condition)	\$946,000	\$600,000	\$304,000	\$812,000	\$235,000
\$10/MtCO ₂ e	\$919,000	\$544,000	\$245,000	\$753,000	\$176,000
\$15/MtCO ₂ e	\$886,000	\$474,000	\$171,000	\$679,000	\$102,000
\$20/MtCO ₂ e	\$853,000	\$404,000	\$ 96,000	\$604,000	\$ 27,000

to be achieved through the entities direct initiatives to reduce GHGs. This could limit market demand in the future for carbon credits. Our sensitivity analyses for GHG reduction credits place a value per metric ton of carbon equivalents in the range of \$3 to \$20. In the O&M cost evaluations (Table 4.05-3), we assumed a value of \$6/MtCO₂e.

4.07 SUMMARY OF FINANCIAL EVALUATIONS

Based on these evaluations, including the opinions of capital cost and O&M cost, as well as the sensitivity analyses, the following conclusions apply:

- Per animal unit, the cluster alternatives are generally lower in both capital and O&M costs than the individual farm alternatives.
- The Waunakee Cluster has higher capital costs than the Middleton Cluster, which is the result of the costs to construct pumping stations and force mains to convey manure to the cluster site and return liquid to the farms.
- The Middleton Cluster has higher annual O&M costs, which mainly result from the high cost of trucking manure to the cluster site and trucking liquid back to the farms.
- The cluster anaerobic digestion alternatives (C-3W and C-3M) and combustion alternatives (C-5W and C-5M) have the lowest annual O&M cost and are expected to save significant annual O&M costs compared to the existing operations. The preliminary cost opinions for the Waunakee Cluster indicate that these alternatives may provide a net operating surplus (revenue exceeds costs).
- The alternatives are very dependent on the actual unit O&M costs noted in Section 4.06. In particular, the cost of trucking, the value of separated solids, and the value of GHG emission reduction credits will be important in determining financial viability of various alternatives.

SECTION 5
NONMONETARY ISSUES EVALUATION

The comparisons made in Section 4 are based almost exclusively on capital and long-term costs. However, each of the alternatives has important nonmonetary considerations that must be evaluated alongside the present value cost to assist in the identification of the recommended alternative. Nonmonetary issues become very important for projects such as those contemplated by this study, where the nonmonetary benefits of the project must be weighed against the costs. Decisions regarding project funding including grants and subsidies are often based on nonmonetary issues such as those presented below. This section includes a description of the nonmonetary issues and a summary of the assigned weighting factors and scores.

5.01 NONMONETARY ISSUES REVIEW

Important nonmonetary issues were selected following a review of the Dane County Manure Feasibility Study Committee's goals and issues included in the County's request for proposals. The relative importance of each nonmonetary issue was then established with input from members of the Manure Management Committee and others having knowledge of the issues. The relative importance was quantified in terms of a weighting factor. Independently of the weighting factor determination, the nonmonetary issues for each of the eight shortlist alternatives were assigned a score on a scale of negative one (-1) to positive one (+1), with zero (0) being neutral. A neutral score was assigned to issues that were neither negative nor positive when compared with current general farming practices in the study area. The scores were multiplied by the weighting factors, and these were summed to arrive at the total nonmonetary score for each alternative. Key nonmonetary goals and issues that were used in this evaluation are described below.

Descriptions of all the nonmonetary issues and criteria for scoring are provided in Table 5.01-1. Weighting factors and scores are provided in Table 5.01-2.

A. Phosphorus Reduction

A primary goal of this study is to reduce the amount of P applied to agricultural land in the upper Lake Mendota watershed, as well as P loads to Lake Mendota, while maintaining a productive agricultural community. All of the alternatives discussed in Section 4 will remove P from manure to some extent. Alternatives that received a positive nonmonetary score were those that remove P from manure and provide a means to reduce the amount of P applied to agricultural land in the upper Lake Mendota watershed. The weighting factor for this issue is 8.5.

B. Water Quality Impacts

Surface water quality is a major consideration in the management of manure in the study area and was one of the primary drivers for this study. Erosion of nutrient rich soils and runoff of manure-laden surface water increases the nutrient loading to surface waters including Lake Mendota and the Yahara River chain of lakes. When nutrients become excessive in surface waters, they can lead to excessive algal growth (or eutrophication) that can result in reduced sunlight, loss of aquatic habitat, and a decrease in dissolved oxygen in the water. On a larger scale, the study area is located in the Upper Mississippi watershed. Therefore, N loadings in the study area contribute to Gulf of Mexico hypoxia (low dissolved oxygen) conditions and the coinciding loss of fish, shellfish, and other aquatic life. Recognizing that nutrients can run off soils and enter

TABLE 5.01-1

NONMONETARY ISSUES CRITERIA

Nonmonetary Issue	Weighting Factor	Factors Contributing to a Positive Score	Factors Contributing to a Negative Score
Phosphorus Reduction		Technologies with the best overall potential for P reduction.	Technologies with the lowest overall potential for P reduction.
Water Quality Impacts		Likely reduction in P content of soils in the study area. Reduction in the potential for manure runoff into surface waters. Reduced potential for water pollution because of phosphorus or ammonia.	Increased likelihood of water pollution.
Air Quality Impacts		Reduction in methane, ammonia, and sulfur air emissions compared with current manure management practices in the study area. Reduction in manure hauling.	Increased emissions to air.
Maintaining Green Space and Associated Water Quantity Impacts		Lower cost alternatives to purchase of development rights or farmland preservation programs. Maintenance of productive, environmentally compliant farms discouraging urban sprawl. Maintenance of green space and soil infiltration capacity such that groundwater recharge is maximized and peak runoff/erosion events minimized.	High cost alternatives that could result in loss of productive farms. Alternatives that increase impervious surface area and/or runoff. Elimination of manure as a nitrogen and OM source potentially resulting in higher likelihood of purchasing feed instead of growing feed crops.
Maintaining Working Farmland and the Associated Culture, Lifestyle, and Aesthetics		Lower cost alternatives. Maintenance of productive, environmentally compliant farms discouraging urban sprawl.	High cost alternatives that could result in loss of productive farms. Elimination of manure as a nitrogen and OM source potentially resulting in higher likelihood of purchasing feed instead of growing feed crops.
Nutrient Transportability		Ability to remove and condense P for more cost-effective export. Ability to remove and reduce the volume of P without removing other valuable components of manure (N, K, OM, and micro-nutrients). Ability to use co-op or other established local system to distribute condensed P.	Inability to transport phosphorus out of the watershed. Removal of other beneficial aspects of manure (N, K, OM or micronutrients).
Greenhouse Gases (GHGs) and Potential Credits		Capture and use of methane; reduction of methane, CO ₂ , N ₂ O, and other GHGs emitted to the atmosphere from long-term storage practices. Potential to sell credits to utilities or climate exchanges.	Increased GHG emissions as compared with current manure management practices in the study area.
Production of Renewable Energy		Production, capture, and sale or use of biogas or heat energy.	Increase in energy use without production of renewable energy.

Nonmonetary Issue	Weighting Factor	Factors Contributing to a Positive Score	Factors Contributing to a Negative Score
Aesthetics/Nuisances		Improvement in odor potential, noise, and similar nuisances when compared to current manure management practices in the study area.	Increased odors and noise; proximity to residential areas. Poor aesthetics of the selected technology.
Safety Issues Related to Mixing Farm and Commuter Traffic		Maintenance of productive, environmentally compliant farms discouraging urban sprawl.	Alternatives that require producers to continue to haul manure on roads used by commuters.
Impact on Roads/Truck Traffic		Improvement in truck traffic when compared to current manure management practices in the study area.	Increase in truck traffic, increase in nonfarm-owned truck traffic where load limits could apply, and proximity to residential areas.
Animal Disease Control		Pathogen destruction; individual farm systems that keep any pathogens on the farm.	Increased potential for pathogens to be transmitted within the same farm, from one farm to another, or from farms to residential areas.
Status of Technology; Reliability		Well-established for manure or well established for wastes that have characteristics similar to manure.	Few or no successful installations, still in research, development or pilot stage.
Ease of Operation		Simple to operate using staff that have basic training.	Complex and requiring more operations staff and/or staff with high level of education and training.
Expandability		Easy to expand in the future to take additional manure or other organic wastes or to comply with new regulations; easy to expand to production of other products such as ethanol and biodiesel.	Difficult to expand or upgrade because of technology, space, or other limitations.
Ability to Treat Other Feedstocks		Ability to treat organics, particularly if it provides a potential revenue source.	Unable to treat other materials.
Regulatory and Permitting Issues		Similar permitted facilities in Wisconsin. Applicable regulations already exist or DNR willing to permit, perhaps with waivers or exemptions from existing rules. Alternatives that lessen the potential impact of winter landspreading and other regulations on individual farms.	Regulatory “grey area” or no current regulations that apply. No similar permitted facilities in Wisconsin along with DNR’s hesitancy to permit. A “do nothing” or minimal alternative that might lead to increased regulation of farms.
Image of Dane County as a Leader in Sustainability		Alternatives that are innovative, implementable, and low energy users, alternatives that maintain productive farms, green space, and the associated environmental sustainability community alternatives that seek to address a wide range of issues at an acceptable cost.	Alternatives that are more costly, difficult to implement, or that use significant energy. High cost alternatives that could result in loss of productive farms.

TABLE 5.01-2

NONMONETARY SCORING SUMMARY

		Alternative No. and Description:																
		Individual Farm Systems						Community Systems										
		F-1		F-2		F-3		C-1		C-2		C-3		C-4		C-5		
		Fine solids separation with polymer addition		Fine solids separation with ferric chloride and polymer addition		Anaerobic digestion followed by solids separation, with ferric chloride and polymer addition		Fine solids separation with polymer addition		Fine solids separation with ferric chloride and polymer addition		Anaerobic digestion followed by solids separation, with ferric chloride and polymer addition		Fine solids separation with ferric chloride and polymer addition followed by drying/pelletizing		Drying followed by combustion		
Projected P Removal, %		40 to 50%		60 to 80%+		60 to 80%+		40 to 50%		60 to 80%+		60 to 80%+		60 to 80%+		~100%		
Nonmonetary Factors:		Weighting Factor	Score	Extension (WF x S)	Score	Extension (WF x S)	Score	Extension (WF x S)	Score	Extension (WF x S)	Score	Extension (WF x S)	Score	Extension (WF x S)	Score	Extension (WF x S)	Score	Extension (WF x S)
Phosphorus Reduction		8.50	0.0	0.0	0.5	4.3	0.5	4.3	0.0	0.0	0.5	4.3	0.5	4.3	0.5	4.3	1.0	8.5
Water Quality Impacts		9.63	0.0	0.0	0.5	4.8	0.5	4.8	0.5	4.8	1.0	9.6	1.0	9.6	1.0	9.6	1.0	9.6
Air Quality Impacts		5.50	0.5	2.8	0.5	2.8	1.0	5.5	0.0	0.0	0.0	0.0	1.0	5.5	0.0	0.0	0.0	0.0
Maintaining Green Space/Water Quantity		6.75	0.5	3.4	0.5	3.4	0.5	3.4	1.0	6.8	1.0	6.8	1.0	6.8	1.0	6.8	1.0	6.8
Maintaining Working Farmland/Culture		7.63	0.5	3.8	0.5	3.8	0.5	3.8	1.0	7.6	1.0	7.6	1.0	7.6	1.0	7.6	1.0	7.6
Nutrient Transportability		8.25	0.5	4.1	0.5	4.1	0.5	4.1	0.5	4.1	0.5	4.1	0.5	4.1	1.0	8.3	1.0	8.3
Greenhouse Gases and Potential Credits		6.25	0.5	3.1	0.5	3.1	1.0	6.3	0.5	3.1	0.5	3.1	1.0	6.3	0.0	0.0	0.5	3.1
Production of Renewable Energy		5.50	0.0	0.0	0.0	0.0	1.0	5.5	0.0	0.0	0.0	0.0	1.0	5.5	-0.5	-2.8	1.0	5.5
Aesthetics/Nuisances		6.13	0.0	0.0	0.0	0.0	0.5	3.1	0.0	0.0	0.0	0.0	0.5	3.1	0.0	0.0	-1.0	-6.1
Safety Issues - Farm/Commuter Traffic		7.38	0.5	3.7	0.5	3.7	0.5	3.7	0.0	0.0	0.0	0.0	0.0	0.0	0.5	3.7	0.5	3.7
Impact on Roads/Truck Traffic		5.38	0.5	2.7	0.5	2.7	0.5	2.7	0.0	0.0	0.0	0.0	0.0	0.0	0.5	2.7	0.5	2.7
Animal Disease Control		7.75	0.0	0.0	0.0	0.0	1.0	7.8	-1.0	-7.8	-1.0	-7.8	1.0	7.8	1.0	7.8	1.0	7.8
Status of Technology; Reliability		6.88	1.0	6.9	1.0	6.9	1.0	6.9	1.0	6.9	1.0	6.9	1.0	6.9	-1.0	-6.9	-1.0	-6.9
Ease of Operation		7.50	0.0	0.0	0.0	0.0	-0.5	-3.8	0.0	0.0	0.0	0.0	-0.5	-3.8	-1.0	-7.5	-1.0	-7.5
Expandability		7.50	1.0	7.5	1.0	7.5	0.0	0.0	1.0	7.5	1.0	7.5	0.5	3.8	0.0	0.0	-0.5	-3.8
Ability to Treat Other Feedstocks		4.63	0.0	0.0	0.0	0.0	1.0	4.6	0.0	0.0	0.0	0.0	1.0	4.6	0.5	2.3	1.0	4.6
Regulatory and Permitting Issues		7.38	0.0	0.0	0.0	0.0	-0.5	-3.7	0.0	0.0	0.0	0.0	-0.5	-3.7	-0.5	-3.7	-1.0	-7.4
Image of Dane County -Sustainability Leader		5.00	0.0	0.0	0.5	2.5	0.5	2.5	0.5	2.5	0.5	2.5	1.0	5.0	1.0	5.0	0.0	0.0
Total Score				38		50		61		36		45		73		37		37

area surface waters, Dane County has banned, with certain exemptions, the residential use of commercial fertilizers containing P. The DNR completed a priority watershed study for Lake Mendota in 1996 and 1997 that included a goal of a 50 percent reduction in P loading to the lake from agricultural and urban sources.

Direct runoff of manure into streams has occasionally caused fish kills in Dane County. This results from the high organic and ammonia content of manure and the subsequent decomposition of the organic matter in the stream, which causes a reduction in dissolved oxygen. Fish require a certain level of dissolved oxygen to live. The potential for manure runoff is greatest during periods of prolonged wet weather, periods of snowmelt during the winter and spring, when the ground is frozen and precipitation occurs, and when manure (either liquid or solid) is spread too close to stream riparian areas.

The surface water quality issue was given a weighting factor of 9.63 because of its high importance in Dane County.

C. Air Quality Impacts

Air quality impacts associated with manure management are often a concern. For example, livestock farmers can have issues with dust, odors, ammonia emissions when manure is land applied to the soil surface, and sulfur and other emissions from uncovered lagoons. Fuel emissions caused by transportation and application of manure can also have a negative impact on air quality. Some of the alternatives reviewed in Section 4 would reduce overall emissions by providing pollution control equipment on air discharges, or reducing the frequency and distance of manure hauling. These alternatives were given a positive nonmonetary score. This issue was given a weighting factor of 5.5.

D. Maintaining Green Space and Associated Water Quantity Impacts

Preservation of open, green space is deemed an important issue by Dane County, and it was given a weighting factor of 6.75. Alternatives that result in higher anticipated positive impacts on water quality were assigned higher nonmonetary scores for this issue, because those are the alternatives that will help maintain productive farms and the associated green space. Preservation of green space is important because it would reduce urban sprawl and the associated negative environmental impacts. These negative impacts include increased stormwater peak runoff events and associated erosion, negative modification of local stream hydrology, deterioration of surface water quality, reduced groundwater recharge, increased urban heat, wildlife impacts, and other impacts. The groundwater recharge issue is particularly important in Dane County where groundwater levels are declining because of the way drinking water supplies and wastewater treatment plant discharges are managed. Urbanization would cause fragmentation of farm land, presenting more operational problems for the farmers related to access to land, longer hauling distances, and other issues. Urbanization would have a negative impact on established agricultural support businesses such as veterinarians and seed and feed dealers and cooperatives. Maintaining green space would provide more flexibility in future land use decisions as compared to urbanized land. Green space also provides separation between communities and

helps those communities retain their unique identities. Green space is also related to culture, lifestyle, aesthetics, commuter traffic, safety, and other issues described below.

E. Maintaining Working Farmland and the Associated Culture, Lifestyle, and Aesthetics

This issue is related to preservation of green space, but it focuses more on the nonmonetary benefits associated with working farmland and its culture, lifestyle, and aesthetics. Dane County culture and history are strongly tied to agriculture. The aesthetics and lifestyle of the rural landscape that surrounds the Madison metropolitan area gives Dane County its unique identity. Having working farms provides the opportunity for Dane County residents to obtain local produce, reducing dependence on distant sources that need to be transported using fossil fuels. Alternatives that would help maintain viable farming operations in the County (assuming the alternative is cost-effective) were assigned positive nonmonetary scores. The weighting factor for this issue is 7.63.

F. Nutrient Transportability

The ability to condense P and export it out of the upper Lake Mendota watershed is a key goal of this project. The weighting factor for this issue is 8.25. The ideal alternative would remove and condense P while leaving the N, K, organic carbon, and other valuable components of the manure for use on local farms. If both the P and the N are removed from the manure, the farmers would need to purchase commercial fertilizers to meet the N needs of their crops. These commercial fertilizers are increasingly obtained from foreign sources, resulting in increased costs and the environmental impacts of long-distance transportation.

G. Greenhouse Gases (GHGs)

Farms that handle animal manure, particularly those that have manure storage lagoons, release methane, carbon dioxide (CO₂), N, sulfur, and other compounds to the air. GHGs including methane, nitrous oxides, and CO₂ contribute to global climate change. Projects, such as anaerobic digestion, that reduce the amount of methane and other GHGs from entering the atmosphere were assigned a higher rating with respect to GHG emissions. This nonmonetary issue was given a weighting factor of 6.25.

GHG reductions and the available carbon credits are also discussed in Section 4 as part of the financial evaluations of the alternatives.

H. Production of Renewable Energy

The State of Wisconsin has a goal of working toward energy independence. According to the Wisconsin Office of Energy Independence Internet site, “Our state’s energy independence strategy relies on our ability to become a leader in groundbreaking research and developing technologies to make alternative energies more affordable and available to all Wisconsin citizens.” Projects that result in a net gain in renewable energy or net reduction in conventional energy use were given a positive nonmonetary score. Such projects are also important to local utility companies who need to minimize new power generation and obtain a certain percentage of their energy from renewable sources. The weighting factor for this issue is 5.5.

I. Aesthetics/Nuisances

Alternatives that result in an improvement in odor potential, dust, noise, and similar nuisances when compared to current manure management practices in the study area were given a positive score. This issue is related to siting of manure management facilities, particularly community systems. Such systems should be sited away from developed residential areas to the extent practical. This issue is also related to the aesthetics of the selected alternative itself, in terms of its systems and structures. The weighting factor for this issue is 6.13.

J. Safety Issues Related to Mixing Farm and Commuter Traffic

As residential development increases in Dane County, the opportunity for commuter and farm traffic to mix on local roads increases. This raises a safety concern because of slow moving or wide farm vehicles combined with commuters. Alternatives that reduce the current number and size of manure trucks on the road were given a positive score. This issue was assigned a weighting factor of 7.38.

K. Impact on Roads/Truck Traffic

Alternatives that could result in a decrease in truck traffic over current farming practices were given a positive score for this issue. There is some question whether increases in nonfarm-owned truck traffic could lead to greater concern over the application of load limits on local roads. In any case, increases in truck traffic and trucks carrying heavier loads will result in more wear and tear on local roads. The weighting factor for this issue is 5.38.

L. Animal Disease Control

Animal disease control is considered a major issue on dairy and other farms, and it was given a relatively high weighting factor of 7.75. A white paper on this issue is under development for the Dane County manure management web page. Alternatives that reduce the potential for on-the-farm, farm-to-farm, or farm-to-community spread of disease-causing microorganisms compared with current practices were given positive scores.

M. Status of Technology; Reliability

Alternatives employing technologies that are well-established for manure, or well-established for materials that have characteristics similar to manure, were given positive scores for this issue. Likewise, alternatives that are otherwise considered reliable in their operations were given a positive score. The weighting factor for this issue is 6.88.

N. Ease of Operation

Alternatives that are relatively easy to operate were given positive scores. This issue is related to the need to hire highly skilled workers to operate the manure management system as compared to farm labor; if highly skilled workers were needed, then it contributed to a negative score. The weighting factor for this issue is 7.5.

O. Expandability

Dane County is interested in technologies that can be relatively easily expanded to allow for one or more of the following:

- Increases in manure production from participating farms.
- Increases in the number of participating farms.
- Ability to accept different organic materials in the future such as those from area industries.
- Ability to expand to different technologies in the future, such as more efficient manure management technologies that may emerge, or a colocated biodiesel or ethanol production plant.
- Ability to accept manure from area farms on a contingency or emergency basis, such as during extreme wet weather events when storage lagoons are full.

Alternatives that can be readily expanded were given a positive score. This issue was assigned a weighting factor of 7.5.

P. Ability to Treat Other Feedstocks

Some alternatives are amenable to accepting other organic materials as feedstocks. For example, anaerobic digesters can generally accept any high strength liquid organic material, and accepting such materials can increase the production of methane and energy. The manure management committee feels it is important to maintain a link between area industries and the farming community, and the valuator assigned a weighting factor of 4.63 to this issue. If an alternative was able to accept such feedstocks and potentially generate revenue from it, this issue was given a positive score.

Q. Regulatory and Permitting Issues

The regulatory issues affecting agricultural practices are fairly complex. For example, a CAFO farm cannot be given a permit for a direct discharge of treated effluent to a receiving stream, whereas an individual or industry can. This issue was given a weighting factor of 7.38 because of its importance to the study. A positive score was assigned for alternatives that were similar to other permitted facilities in Wisconsin or where applicable regulations already existed. Positive scores were also given to alternatives that we believed the DNR would be willing to permit, perhaps with waivers or exemptions from existing rules, based on our conversations with DNR staff. Alternatives that lessen the impact of potential CAFO regulations, local ordinances such as those related to winter landspreading, and other regulations on individual farms were also given a positive score. A positive bias was given to community systems since a community solution should lead to a decreased probability of enhanced nutrient management regulations imposed on the farm community.

R. Image of Dane County as a Leader in Sustainability

Dane County is proud of its reputation for being innovative and a leader in sustainable practices. This nonmonetary issue was given a weighting factor of 5.0. Alternatives that are innovative, relatively easy to implement today, low energy users, and that are considered sustainable overall were given a positive score. Alternatives that maintain productive farms and green space and community alternatives or systems that seek to address a wide range of issues at an acceptable cost were likewise given a positive score.

5.02 SUMMARY

Table 5.01-2 presents a summary of the nonmonetary scores developed for each of the eight manure management alternatives. The two anaerobic digestion alternatives have the highest nonmonetary scores, with Alternative C-3 (cluster anaerobic digestion) having the highest overall score of 73 and Alternative F-3 (individual farm anaerobic digestion) having a score of 61. The alternatives with fine solids separation and ferric chloride addition, Alternatives F-2 and C-2, were rated the next highest with scores of 50 and 45, respectively. The remaining alternatives were all assigned similar scores of 37 or 38.

SECTION 6
POTENTIAL FINANCIAL ASSISTANCE

This section presents a discussion of a range of financial assistance opportunities for manure management projects. It should be noted that available financial assistance programs change regularly. Therefore, the information presented in this section should be considered as a starting point.

6.01 INTRODUCTION

Financial assistance for manure management projects is dependent on several factors, particularly the type of ownership, financial need, and type of project. For example, farmer-owned facilities may be more eligible for certain grants than a venture capital investment firm-owned facility. Likewise, a renewable energy project (e.g., anaerobic digestion, manure combustion) is likely to be more eligible for grants than a project that simply separates solids to improve nutrient management.

It is important to realize that financial assistance programs for manure management projects are constantly evolving and new programs are being developed. In addition, the existing programs may be modified, expanded, or discontinued in the future. The following paragraphs present a summary of programs currently available from known local, state, and federal sources.

6.02 LOCAL SOURCES

A. Governmental Bonding or Tax Increment Financing (TIF) Districts

If the project is owned by the County or a local municipality, traditional methods of governmental financing may be available, including bonding or TIF districting. Traditional county or municipal bonding could be used to finance the project in the same manner that most other capital projects are financed by such governmental entities.

TIF districts utilize future gains in taxes to finance current improvements that will create tax gains. The increased tax revenues are the tax increment, and that increased revenue is used to pay the finance debt that was issued to pay for the project in question. TIF districts are designed to channel funding toward improvements in distressed or underdeveloped areas where development would not otherwise occur. Therefore, prior to considering TIF district opportunities to finance a manure management project, legal and financial consultation would be needed to determine whether TIF district financing is a viable alternative.

B. Utility Companies and Related Organizations

Local utility companies may be interested in providing financial assistance for projects that use renewable fuels such as manure to generate energy. Alliant Energy and Madison Gas and Electric Company have expressed interest in a community digester or similar project. Grants from these companies may be available regardless of the project ownership structure selected.

Wisconsin Public Power Inc. administers a Renewable Energy Incentive Program for customers served by its 48 municipal utility members in Wisconsin, Iowa, and Michigan. This incentive is in lieu of the Wisconsin Focus on Energy Incentive for those municipal utilities served by WPPI that offer their own

Commitment to Community program. The incentive has been updated for 2007 to include some commercial customers.

6.03 STATE OF WISCONSIN SOURCES

A. Focus on Energy

Focus on Energy, Wisconsin's energy efficiency and renewable energy initiative, is offering a new grant for dairy farms, wastewater treatment plants, and food processing plants. Businesses and organizations are eligible for Focus Grants if they purchase natural gas or electricity from a participating Wisconsin utility. Recipients can receive up to \$250,000 in implementation grants to finance and install an anaerobic digester that produces heat and/or electricity from organic material such as manure. These grants provide financial support for developing large renewable energy systems with a capacity greater than 20 kW or 5,000 therms per year.

Feasibility Study Grants are also available. They are intended to increase the ability of businesses and organizations to make informed decisions about using renewable energy systems by understanding and solving technical uncertainties. Focus on Energy can fund up to 50 percent of these study costs up to a maximum of \$10,000.

Development Grants are also available to provide financial support for large projects that are not eligible for Implementation Grants. These grants cofund complex feasibility studies, environmental permitting, financing, and other developmental activities. Focus on Energy can fund up to 50 percent of the project costs, up to a maximum of \$50,000.

B. Lake Protection Grants

If the project is owned by the County, a lake protection district, or a local municipality, the project or a portion of it may be eligible for the DNR's Lake Protection Grant program. Potential eligible projects include the following:

1. Development of local regulations or ordinances to protect lakes and the education activities necessary for them to be implemented (these grants are limited to \$50,000).
2. Lake management plan implementation projects recommended in a plan and approved by the DNR. These projects may include watershed management projects, lake restoration, diagnostic feasibility studies, or any other projects that will protect or improve lakes.

Awards may fund up to 75 percent of project costs (maximum grant amount of \$200,000 unless otherwise specified above). The application deadline is May 1 of each year. Maintenance and operation of facilities are not eligible for grants.

The DNR recommends a preapplication meeting because of the size, complexity, and technical nature of these projects, especially if the project requires plan or permit approvals. This will ensure the application will be complete and can be evaluated and considered for funding.

C. Department of Agriculture, Trade, and Consumer Protection (DATCP) Grants

1. Agricultural Development and Diversification (ADD)

DATCP administers grant programs related to agricultural development and renewable energy and sustainability projects. One of these is the ADD Grant Program. The ADD program solicits proposals for projects that are likely to stimulate Wisconsin's agricultural economy through the development and exploration of new value-added products, new markets, or new technologies in agriculture. ADD grants are awarded each year and the deadline for submissions is normally in mid-March. In 2007, the ADD program had approximately \$380,000 available with a maximum grant amount of \$50,000. Grant applicants must provide at least 25 percent of eligible project expenses. Additional information can be found on the Internet at:

<http://www.datcp.state.wi.us/mktg/business/marketing/val-add/add/index.jsp>.

2. Grow Wisconsin

For farms that produce specialty dairy products, the Grow Wisconsin Dairy Team is a team of Wisconsin interagency members that coordinates and focuses resources for dairy farmers modernizing their businesses and for processors streamlining the supply chain. Since 2004, the team has administered more than \$1.5 million in grants to the dairy industry and provided technical assistance to nearly 500 farms. This assistance is acting as a catalyst for reinvestment and innovation in the dairy sector. The Dairy Business Innovation Center of Wisconsin also assists specialty producers. The Internet site address for these programs is:

<http://www.datcp.state.wi.us/mktg/business/marketing/val-add/initiative/index.jsp>.

3. Alternative Fuels

DATCP is also promoting and supporting use of alternative fuels including biofuels (such as those produced in a manure digester), ethanol, and biodiesel.

<http://power.wisconsin.gov/section.asp?linkid=1124&locid=131>.

4. Biobased Industry

DATCP's Biobased Industry Opportunity Grant Program is intended to create new enterprises and opportunities through biobased industry initiatives. Biobased industries include energy, fuels, or value-added chemicals and materials generated from plant, agricultural, forestry, or other biological materials. Proposals were solicited in March 2006. Currently (2007) there is no funding available in this program.

5. DATCP Soil and Water Resource Management Grants

DATCP awards annual grants to eligible county Land Conservation Committees and others to pay for county conservation staff and to finance landowner cost-sharing. To be eligible for grant funds, the county must have a DATCP-approved land and water resource management plan. DATCP awards grant funds as part of an allocation process working with the DNR. The allocation process involves several steps. Grant funds must be spent in the year allocated, except DATCP may extend cost-share funds for an additional year for specific projects.

6. Summary

DATCP's overall summary of agricultural grant and loan funding sources, *Got Moo-la*, may be found on the Internet at:

http://www.datcp.state.wi.us/mktg/business/business_resources/pdf/Wisconsin_Business_Resources.pdf.

6.04 FEDERAL SOURCES

A. The Environmental Quality Incentives Program (EQIP)

The EQIP was reauthorized in the Farm Security and Rural Investment Act of 2002 (Farm Bill) to provide a voluntary conservation program for farmers and ranchers that promotes agricultural production and environmental quality as compatible national goals.

EQIP offers financial and technical help to assist eligible participants install or implement structural and management practices on eligible agricultural land. EQIP offers contracts with a minimum term that ends one year after the implementation of the last scheduled practices and a maximum term of ten years. These contracts provide incentive payments and cost-shares to implement conservation practices.

Persons who are engaged in livestock or agricultural production on eligible land may participate in the EQIP program. EQIP activities are carried out according to an environmental quality incentives program plan of operations developed in conjunction with the producer that identifies the appropriate conservation practice or practices to address the resource concerns.

The Natural Resources Conservation Service (NRCS) approves the plan. The Dane County contact for this program is located at the Madison Service Center for NRCS [1 Fen Oak Court, Madison, Wisconsin, 53718-8812; (608) 224-3767]. The guidelines for Wisconsin for 2008 may be found at:

<ftp://ftp-fc.sc.egov.usda.gov/WI/eqip/2008/cookbook08.pdf>.

EQIP may cost-share up to 75 percent of the costs of certain conservation practices. Incentive payments may be provided for up to three years to encourage producers to carry out management

practices they may not otherwise use without the incentive. However, limited resource producers and beginning farmers and ranchers may be eligible for cost-shares up to 90 percent. Farmers and ranchers may elect to use a certified third-party provider for technical assistance. An individual or entity may not receive, directly or indirectly, cost-share or incentive payments that, in the aggregate, exceed \$450,000 for all EQIP contracts entered during the term of the Farm Bill.

The ability to use EQIP funds from the U.S. Farm Program will also play a major role in determining the ideal ownership structure and financing alternatives. The Farm Bill designates that 60 percent of the total EQIP monies be used for livestock waste projects, but, even so, demand for the funds will likely outstrip the supply. Active intervention by the state NRCS office could be decisive in determining the availability of such funding for this project. Potential EQIP funding is so important that its availability might dictate the recommended ownership structure.

B. Energy Policy Act of 2005

The final version of the energy bill was signed by the President on August 8, 2005. It included a wide range of tax breaks and incentives for traditional energy interests as well as alternative energy sources. Some of the renewable energy provisions include the following:

- A two-year extension of the Production Tax Credit (described in this section).
- A two-year extension of excise and income tax incentives for biodiesel.
- A mandate to increase ethanol consumption to 7.5 billion gallons by 2012.
- The creation of Clean Renewable Energy Bonds (the federal government pays a tax credit to the bondholder in lieu of the issuer paying interest to the bondholder). \$800 million has been authorized.
- A \$20/green ton credit for using biomass to produce energy, heat or transmission fuels (Section 210).
- Tax credits for hybrid vehicle purchases.
- Tax credits of 30 percent or up to \$2,000 for the purchase of residential solar panels or hot water heating.

C. Renewable Electricity Production Tax Credit

Under the new Energy Policy Act of 2005, the Production Tax Credit (PTC) was extended to cover facilities placed in service through the end of 2007. The duration of the PTC is 10 years. Hydropower and Indian coal were added as new qualifying resources. Other eligible resources include wind, closed-loop biomass, open-loop biomass, geothermal energy, solar energy, small irrigation power (150 kW to 5 MW), landfill gas, municipal solid waste, and refined coal. Taxpayers are allowed a credit of 1.5 ¢/kWh (adjusted annually for inflation or 1.9 ¢/kWh in 2005) for electricity generated from wind, solar, closed-loop biomass, and geothermal projects under

Section 45 of the Internal Revenue Code. Open-loop biomass, small irrigation, hydropower, and municipal solid waste receive .9¢/kWh. For more information, see:

<http://www.dsireusa.org>.

D. Executive Order 13123–Federal Green Power Purchasing Goal

Executive Order 13123 required federal agencies to increase their percentage of renewable energy use to 2.5 percent of total consumption by 2005. Individual agencies voluntarily chose to purchase renewable energy or Renewable Energy Certificates to support this goal. Based on its success, the goal was extended under the Energy Policy Act of 2005 to 5 percent in 2010-2012 and 7.5 percent in 2013 and thereafter.

E. Section 9006 of the 2002 Farm Bill

The Farm Security and Rural Investment Act of 2002 (Farm Bill) requires the United States Department of Agriculture (USDA) to implement a program of loans, loan guarantees, and grants to agricultural producers and rural businesses for renewable energy systems and energy efficiency. More details on these programs are provided under the “USDA Programs” section of this document.

F. Federal Fiscal Incentives

1. Accelerated Depreciation

Solar, wind, and geothermal property placed in service after 1986 can be depreciated using the Modified Accelerated Cost-Recovery System (MACRS). The property class for most renewable energy equipment is five years. A seven-year tax life applies to property used in the conversion of solid waste and biomass into a solid, liquid, or gaseous fuel. See <http://www.ors.gov> for additional information.

2. Tax-Exempt Financing for Biomass

Assuming that the facility has more than 10 percent private business use, a biomass project can qualify for tax-exempt financing if it fits into one of two categories, (1) the project supplies gas or electricity to an area no larger than two contiguous counties or one city and a contiguous county or (2) the facility is a solid waste disposal facility.

3. Regional agricultural lenders affiliated with the Farm Credit Administration

The previously mentioned DATCP publication, *Got Moo-!a*, includes a listing of banks and Farm Credit contacts who provide loans to small businesses including farms.

G. US Department of Agriculture (USDA)

1. Rural Utility Service (RUS)

The RUS supports rural utilities in keeping their technology up to date and expanding rural infrastructure. RUS provides loans and loan guarantees to utilities for system improvements and the construction of on-grid and off-grid renewable systems. Additional information on loans and grants is available on the Internet at:

<http://www.usda.gov/rus/electric/loans.htm>.

<http://www.usda.gov/rus/electric/hecgp/index.htm>.

USDA's Renewable Energy Systems and Energy Efficiency Improvements programs assist farmers, ranchers, and rural small businesses in developing renewable energy systems and making energy efficiency improvements to their operations. The USDA provides funding by issuing a Notice of Funds Availability. Renewable energy systems can receive up to \$500,000 but no more than 25 percent of the total project cost.

Eligible technologies include solar water heat, solar space heat, photovoltaics, wind, biomass, geothermal electric, geothermal heat pumps, hydrogen, anaerobic digestion, renewable fuels, fuel cells, and energy efficiency. See these Web sites:

<http://www.rurdev.usda.gov/rd/farmbill/9006resources.html>.

<http://www.dsireusa.org/documents/Incentives/US05F.htm>.

<http://www.dsireusa.org/documents/Incentives/US05Fa.pdf>.

2. Rural Cooperative Development Grant Program (RCDG)

Grants are available for the development of new cooperatives or improvement of existing cooperatives as part of USDA's mission to improve economic conditions in rural areas. Funding of up to \$300,000 per cooperative is available, and recipients must contribute at least 25 percent of the total project funds. Additional information can be found at:

<http://www.rurdev.usda.gov/rbs/coops/rcdg/rcdg.htm>.

3. 1890 and 1862 Land-Grant Institution Initiative

This program seeks to develop income-producing projects for underserved rural communities that are traditionally dependent on agriculture. The University of Wisconsin-Madison is classified as an eligible 1862 institution. Funding can be used to:

- Sponsor business conferences and workshops.
- Finance rural businesses.
- Provide technical assistance to new and existing businesses, including cooperatives.
- Assist communities in leveraging other resources via state, local, private, and/or public funding.

- Assist businesses through the application process.
- Offer courses in business development.
- Provide computer labs where community members can have access to other rural economic development sources on the Internet.
- Establish business incubator services.

See <http://www.rurdev.usda.gov/rbs/oa/1890.htm> for more information.

6.05 OTHER PROGRAMS

A. Carbon Offsets

In many countries around the world, carbon dioxide is being traded as a commodity—just like bushels of corn or barrels of oil. Based on an upper limit of allowable emissions, countries and companies trade “allowances” and “emissions reductions” as a way to comply with regulations. A company with high emissions can buy “emissions reduction units” or make reductions within its own operations. In many cases, it will be less expensive to buy the allowances on the market or make pollution reductions at another company in exchange for the pollution offsets. The concept of emissions trading originated in the United States Environmental Protection Agency (EPA), and many state and local governments in the United States support emissions trading as a compliance tool. In addition to reducing pollution, “sequestering” or trapping carbon can create tradable credits. For example, planting trees or using conservation practices in farming may qualify for credits.

The Kyoto Protocol is the international treaty that governs global emissions trading. The United States is not a participant in the Kyoto Protocol. However, there are other methods and measures used to trade carbon credits. For example, in the United States the Chicago Climate Exchange (CEC) has a voluntary trading program for companies and organizations that want to gain experience with trading or are making reductions on a voluntary basis.

In California and several states in the Northeast, emissions registries are being developed that will support trading. More than 150 cities have made commitments to combat global warming, and it is likely that many will embrace the concept of carbon credits as a tool for reaching their environmental goals. It is also likely that new opportunities will appear for farmers and ranchers to obtain credit for the development of projects that reduce GHGs.

B. Programs in Other States

Other states have incentive programs for assisting producers who live in high phosphorus areas. These types of programs, if implemented in Wisconsin, could be beneficial to producers in high phosphorus areas such as those in Dane (and perhaps nearby counties). Some examples of assistance programs from other states (Maryland, Pennsylvania, and Iowa) are provided here.

1. Maryland Manure Management Programs

The Manure Transport Program helps poultry, dairy, beef, and other animal producers cover the costs of transporting excess manure off their farms. Animal producers with high soil P levels or inadequate land to spread their manure can receive cost-share assistance of up to \$20 per ton to transport excess manure to other farms or alternative use facilities that can use the product safely. To support Maryland’s goal of transporting 20 percent of the poultry litter produced on the Lower Eastern Shore to other regions, cost-share rates are 20 percent higher for farms located in Dorchester, Somerset, Wicomico or Worcester counties. In addition, new guidelines were adopted to streamline the program and to make it easier for dairy farmers and other nonpoultry animal producers to transport manure within their own operation, provided the manure is moved more than one mile from the manure production or storage site.

In FY 2004, Maryland’s Manure Transport Program provided farmers with \$295,356 in state grant payments to transport 44,292 tons of manure away from areas with high soil P levels, an increase of more than 25 percent over 2003. Cost-share funds to transport poultry litter—comprising the bulk of the manure transported—were matched by Delmarva poultry companies, bringing the total amount of financial support provided to \$581,162.

Maryland’s Manure Matching Service links farmers who have excess animal manure with nearby farmers or alternative use projects that can use the waste as a nutrient source. The goal of the service is to reduce the potential impact from animal waste runoff to Maryland’s streams, rivers, and the Chesapeake Bay by establishing a marketplace where farmers can sell their excess manure to buyers who need the valuable nutrients it contains for crop production or alternative use business ventures. The service is free and available to both sending and receiving operations.

Authorized by the Water Quality Improvement Act of 1998, Maryland’s Manure Matching Service is also designed to foster new markets for manure suppliers by encouraging the development of alternative animal waste management technologies such as waste-to-energy, fertilizer manufacturing, and composting.

2. Other Manure Matching Services

Other states have implemented manure matching programs similar to the Maryland program. For example, the Pennsylvania Small Business Development Centers worked jointly with the Pennsylvania State Conservation Commission to develop the Pennsylvania Manure Trader Web site. The Web site (www.manuretrader.org) is a free resource intended to facilitate the beneficial use of excess manure. Registered users can post both “manure wanted” listings as well as “manure available” listings. Manure listings can include details such as type, quantity, frequency of availability, geographic location, and date listed.

In Iowa, a similar manure matching program was developed on a more local level within the South Fork of the Maquoketa River Watershed. The South Fork Maquoketa Water Quality Project began in July 2004 with the goals of reducing sediment, bacteria, and nutrients delivered

to the Maquoketa River and ultimately to Backbone Lake. One aspect of the project included cooperation and a financial donation from Iowa Pork Producers Association (IPPA) to collect water monitoring samples as well as to develop a watershed directory for manure trading. The directory lists those in the watershed with excess agricultural manure and those who can use the manure in environmentally friendly end-uses. The directory is also intended to feature other useful information on water quality, nutrient credits, and local plot data.

There are numerous other programs in other states that have been developed and continue to be developed.

SECTION 7
ALTERNATIVE BUSINESS STRUCTURES AND OWNERSHIP

The discussion in this section is focused on the ownership and potential business structure of a community or joint/cluster manure management facility. However, several of the potential ownership alternatives are applicable to single-farm installations of manure management equipment and systems.

7.01 INTRODUCTION

Implementation of a manure management technology at a single farm or on a community/cluster basis is an added load on the farmers' already limited resources. Some of the challenges with respect to these systems include the following:

- The operations and maintenance requirements are above and beyond normal farming operations.
- The operational and technical skills may require special training and possibly the addition of operations staff.
- The business management requirements may require the establishment of a separate entity, depending on the number of farms involved and the technology employed.

The business model required to own and operate a manure management facility could take one of several forms, and these are discussed below. Table 7.01-1 presents a summary of these types of ownership, including advantages and disadvantages of each.

7.02 INDIVIDUAL FARM OWNERSHIP

Most of the manure management applications that have been implemented to date have been at individual farms and include solids and sand separation and/or anaerobic digestion. The significant majority of these installations have been owned by the farm at which the technology is employed, while a much lower number have been owned and operated by third parties as discussed below.

The farm-ownership model works very well for single-farm applications, especially if the technology being employed is fairly low maintenance and does not require a great deal of specialized operator training and certifications. For the cluster applications, ownership by an individual farm may be considered if one of the farms wishes to assume that role and responsibility.

7.03 COOPERATIVE OWNERSHIP

Dairy farmers have a long history of successful cooperatives (co-ops) for the milk production side of the business, and a similar co-op model may work well for managing manure from multiple farms on a cluster basis. The manure management operation would be owned and controlled entirely by the farms in the cluster co-op. The co-op farmers would supply feedstock (manure) to the facility and, depending on the technology employed, may also take back a portion of end-products from the operation. For example, if the cluster co-op installed a digester and solids separation equipment, the co-op farmers would likely take back the liquid fraction of the digested manure for irrigation and fertilizer value.

TABLE 7.01-1
COMPARISON OF OWNERSHIP ALTERNATIVES

Ownership Type	Advantages	Disadvantages
Farmer-Owned: Single or Cooperative	<ul style="list-style-type: none"> ▪ Better input to serve farmers' needs. ▪ Decisions made to benefit the farm as a whole, not just the bottom line of the manure management business. ▪ Many milk producers are very familiar with the co-op approach. ▪ If manure management costs are reduced, farmers realize benefits directly. 	<ul style="list-style-type: none"> ▪ Added operational and maintenance labor and costs. ▪ Not a core part of most farming operations. ▪ Requires varying levels of specialized technical skills.
Third-Party Technology Company	<ul style="list-style-type: none"> ▪ Very good knowledge of the treatment system. ▪ Potentially better able to make operational adjustments to improve treatment processes. ▪ Less of a risk for a large company. ▪ Farmers can focus on core farming business. 	<ul style="list-style-type: none"> ▪ Farmers would have less control of byproducts returning to their land. ▪ Decisions may not be made with the entire farm operation taken into consideration. ▪ If manure management costs are reduced, farmers may not realize the full benefit.
Third-Party Power Utility	<ul style="list-style-type: none"> ▪ If energy production is included, good knowledge of this market and of energy generation. ▪ Typically large companies with better access to capital for significant projects. ▪ Less of a risk for a large company. ▪ Farmers can focus on core farming business. 	<ul style="list-style-type: none"> ▪ Farmers would have less control of byproducts returning to their land. ▪ Decisions may not be made with the entire farm operation taken into consideration. ▪ If manure management costs are reduced, farmers may not realize the full benefit.

Ownership Type	Advantages	Disadvantages
Third-Party Private Investment	<ul style="list-style-type: none"> ▪ Potentially better access to capital for significant projects. ▪ Less of a risk for a large company. ▪ Farmers can focus on core farming business. 	<ul style="list-style-type: none"> ▪ This type of manure management business may not be a core business of the third-party investor. ▪ Farmers would have less control of end-products returning to their land. ▪ Decisions may not be made with the entire farm operation taken into consideration. ▪ If manure management costs are reduced, farmers may not realize the full benefit.
Combination Co-op/Third Party	<ul style="list-style-type: none"> ▪ Better input to serve farmers' needs. ▪ Decisions could be made to benefit the farm as a whole, not just the bottom line of the manure management business. ▪ Many milk producers are very familiar with the co-op approach. ▪ If manure management costs are reduced, farmers may realize benefits directly. ▪ If established properly, could result in a good match of risk and reward for the farmers and the third party. 	<ul style="list-style-type: none"> ▪ Probably the most complex form of ownership.
Government	<ul style="list-style-type: none"> ▪ Increased scrutiny for design elements, financing, and operations may improve chance of success. ▪ Other similar models have been successful: MMSD, Dane County Landfill, Dane County yard material composting operations. ▪ Easier to obtain DNR and other regulatory permits. ▪ Can accept manure from any farm located within the jurisdiction of the governing entity. 	<ul style="list-style-type: none"> ▪ Farmers would have less control of end-products returning to their land. ▪ Capital and operating costs may be higher to meet higher standards. ▪ If manure management costs are reduced, farmers may not realize the full benefit.

However, as another example, if the technology employed was drying followed by manure combustion, there may be no end-products taken back to the individual co-op farms.

As a closed cooperative, outside investors could not invest in the project. However, the co-op could consider accepting manure from farmers outside of the co-op and/or other feedstocks from industrial and commercial sources. This would benefit the co-op by providing an additional revenue stream and, in the case of an anaerobic digestion facility, could improve the biogas production and electrical generation output, which would improve the financial viability of the project.

7.04 THIRD-PARTY OWNERSHIP

This type of ownership arrangement involves investment, and therefore ownership, from persons or corporations outside the farm cluster. The farmers' involvement is normally limited to delivering manure to the facility at an agreeable price. In addition, depending on the location of the facility and the type of technology employed, the farmer may purchase heat, electricity, or other byproducts from the owner.

This option can be attractive to farmers because it can lower their manure management and disposal costs and simplify their farming operations. In addition, operations, maintenance, permitting, and regulatory matters would typically be handled by the third-party owner.

Three types of investor entities are likely the most common and are discussed below.

A. Technology Company Ownership

This type of investment comes from the developers and/or vendors of treatment and/or management equipment and technologies. As such, the owner has intimate knowledge of the equipment and operation of the system. The system developer often provides turn-key design and construction services for the project and has complete ownership of the facility. Operational expertise is normally provided by the developer as well.

This type of project development has been used successfully for industrial wastewater treatment projects for several years and has also been successfully used at the farm-scale for anaerobic digestion of manure for energy generation.

B. Power Utility Ownership

Many power utilities are developing and/or making significant investments in renewable energy programs. In Wisconsin and elsewhere, utilities have invested in on-farm anaerobic digestion systems for manure treatment and electrical generation. Several years ago, it appeared to be more common for the utilities to actually invest in the projects. In particular, several projects were implemented in which the utility financed and owned the electrical generation component of the overall system and purchased the biogas from the farmer-owned anaerobic digester. In more recent years, the trend appears to be moving away from utility ownership of these facilities and more toward assisting owners and project developers in financing such projects and purchasing renewable energy credits from the owner.

However, given the interest in Dane County for sustainable design, renewable energy, and related topics, as well as the interest and involvement in this project from the two local utilities, we believe ownership by one or both of the local utilities may be a viable option and should be considered.

C. Private Investment Organization

This type of ownership would likely be through a diversified investment company. The manure management facility would be owned by a separate company that may have no ties to the area or to farming in Dane County. The farmers would likely have little control over the operation of the facilities.

This type of ownership arrangement is not common at the present time. However, with the development of new technologies, the development of carbon markets, and the realization of their value, investment into this type of company is likely to be more common in the future.

7.05 COMBINATION CO-OP/THIRD PARTY OWNERSHIP

The option would include a farmer co-op arrangement made up of various farmers and other feedstock suppliers as well as nonfarmer investors. The farmer co-op would contribute a portion of the investment; all remaining capital would come from individual nonco-op investors.

This type of arrangement probably provides the best flexibility in terms of financing, business operations, and related issues. However, it may also be the most complex ownership arrangement, and significant effort would be required to develop an effective and equitable model.

7.06 GOVERNMENT OWNERSHIP

There have been a few cases in the United States in which a government entity has constructed a manure management facility and operates the system on an ongoing basis. The following paragraphs discuss two of these systems.

The Port of Tillamook Bay in Oregon constructed, owns, and operates a centralized anaerobic digester to biologically process the manure from about 4,000 of the county's 30,000 dairy cows. The project was developed over 14 years and was built in 2003. The manure processing facility includes anaerobic digestion, solids separation, and biogas-to-electricity generation. Manure is transported to the facility by Port employees, and liquid end-products are transported back to the farmers' field and land-applied. The facility produces electricity, and separated fiber is recovered for use by a potting soil manufacturer. The Port plans to construct additional facilities to serve other farms in the county if the current system proves financially viable and profitable.

In 2007, the Cayuga County Soil and Water Conservation District in Auburn, New York, is constructing a community digester facility to address concerns of manure-related odors and to improve the water quality in Cayuga County. The Cayuga Regional Digester first phase construction program will process approximately 39,000 gpd of dairy manure using anaerobic digestion and solids separation (screw press). Approximately 34,000 gpd of liquid end-products will be land-applied and 25 tons/day of solids will be composted. The facility has contracts to accept and process manure from several farms in the area and is also pursuing additional food processing waste materials that could be fed to the system to

generate additional electricity. The District plans to use a contract transportation company to haul manure from each farm and return processed liquid end-products to those same farms. The initial Phase 1 facility has an electrical generation capacity of approximately 625 kW with future generation potential of nearly 2,000 kW.

While governmental ownership of manure management facilities is not common in the United States, the potential does exist for such a government-owned facility. Dane County would be one governmental agency that may be suited for such an operation. The County already operates similar facilities that manage solid wastes and is routinely engaged with the farming community. The facility model could be similar to that currently employed by the Dane County landfill and yard material composting sites. A tipping fee or similar fee structure would be established for accepting manure, and farmers would be allowed to deliver manure based on an allocation model that would need to be developed. In addition, the byproducts from the manure processing could be sold back to the farmers as appropriate or to other markets.

Another potential agency is the Madison Metropolitan Sewerage District (MMSD) or similar manure management district. MMSD has recently indicated that they do not intend to become engaged in manure management, and therefore, they are not a likely candidate at this time. However, using the MMSD model and establishing a new manure management district may be an option. This body would function similar to sanitary districts and could have similar political and taxing authority.

SECTION 8
CONCLUSIONS AND RECOMMENDATIONS

The purpose of this study was not to select a single best manure management strategy, but rather to evaluate multiple strategies to determine which of these could feasibly meet Dane County's main goals of strengthening the livestock industry while protecting water quality from manure management impacts. The previous chapters developed alternative manure management strategies for individual farms and clusters of farms, compared the strategies based on cost and nonmonetary factors, and identified potential financing sources and business structures for manure management facilities. This chapter presents the main conclusions of the report and recommended next steps to move from this feasibility analysis to detailed planning.

8.01 CONCLUSIONS

The following conclusions are provided to summarize the conclusions drawn in this report and to provide the bases for our recommendations:

- There is a great deal of interest from the Dane County farming community to develop manure management strategies. Manure management at many Dane County farms requires long hauling distances and land rental for land application of the manure at agronomic rates.
- Water quality impacts from land application of manure have been shown to be significant, and manure is a major source of phosphorus loading (and other nutrient loading) to surface waters within the Upper Lake Mendota Watershed.
- Cluster manure management strategies appear to offer significant economies of scale with respect to capital costs compared to the individual farm systems. In general, while comparing similar manure management strategies, the capital cost projections of the cluster systems are approximately 50 to 75 percent of the capital cost of the individual farm systems when compared on a "per A.U." basis.
- Some of the cluster management strategies have significantly lower annual O&M cost projections (per A.U. basis) than the existing annual O&M costs at the farms as well as the individual farm manure management strategies. In particular, Waunakee Cluster Alternatives C-2W, C-3W, and C-5W, as well as the Middleton Cluster Alternatives C-3M and C-5M, could significantly reduce annual O&M costs and may generate net revenues for the farms.
- The Waunakee Cluster strategies have higher capital costs compared to the Middleton Cluster, which is mainly the result of the added infrastructure required to pump manure to the cluster management facilities rather than trucking the manure. However, because manure trucking is essentially eliminated for the Waunakee Cluster, the projected annual O&M costs are much lower for the Waunakee Cluster compared to the Middleton Cluster.
- Given the proximity of the Waunakee Cluster farms to each other and the potential to pump manure rather than haul manure to the site, the Waunakee Cluster alternatives appear to offer more advantages and better long-term cost-effectiveness than the

Middleton Cluster alternatives or individual farm alternatives. There may be other small clusters similar to the Waunakee Cluster that could also be identified in Dane County.

8.02 RECOMMENDATIONS

Our recommendations recognize that this feasibility study was an important step in the process of implementing improved manure management in Dane County. However, it is only one step and additional effort is required to continue moving forward. The following recommendations are provided to indicate what additional steps should be taken to further define how best to implement such a project.

1. Continue discussions and information exchange with area Dane County farmers to assess on-going interest and promote community solutions.
2. At the County level, determine what level of financial commitment is reasonable to invest in the additional planning, design, and ultimate construction of a community (or individual) manure management strategy.
3. At the County level, discuss and determine whether such a facility could or should be owned and operated by the County. This may be affected by the level of interest in ownership among farmers.
4. Conduct a Facility Planning Study to further refine and develop the scope of select alternatives and strategies included in this report with a focus on the alternatives that appear most viable (Waunakee Alternatives C-2W, C-3W, and C-5W; Middleton Alternatives C-3M and C-5M). This includes identifying potential site locations, verifying manure quantities and other potential feedstocks, working with system vendors to develop preliminary layout(s) of alternatives and more accurate cost opinions (capital and O&M), and conducting a detailed analysis of overall manure management practices on the affected farms. The output of this study would include an overall recommended manure management strategy and associated costs, which could then be used to better define potential ownership of the facility, operation of the facility, and funding programs that could help finance a project to construct the facility. The Facility Planning Report would provide a more refined and detailed definition of the project scope and potential costs to provide to interested third-party technology developers, farmers, and County officials.
5. Define agronomic and related crop management impacts that would result from a manure management facility, and include such impacts in the facility planning analyses.
6. Continue to investigate funding and financing opportunities for manure management facilities.
7. Investigate potential GHG emission reduction credits in more detail and determine what additional steps are needed to obtain maximum credit for such a project.

8. Evaluate the capital and O&M costs from actual full-scale operations in the United States, and estimate how those costs may translate to a similar operation in Dane County.

Assuming the foregoing recommendations are completed, the steps required to implement the final project(s) will be dependent on determining facility ownership and the method of project delivery. For example, if the County decides to own and operate the facility, the next steps would likely be for the County to develop operational plans, establish contracts with farmers, apply for grants, research appropriate GHG exchanges and programs, and develop final design drawings and specifications for construction of the project. Alternatively, if a third-party delivery option were selected for the project, the County (on behalf of the farming community) or the farming community itself may engage several potential third-party developers and request preliminary proposals based on the Facility Planning Report. For any combination of ownership and project delivery, however, we recommend that the County maintain involvement throughout the planning, design, construction, and operation of the facility.

March 28, 2007

«FNAME» «LNAME»
«FARM»
«ADDRESS»
«CSZ»

Dear «FNAME»,

As you may have heard, Dane County has asked Strand Associates, Inc. to complete a manure management feasibility study. The study is scheduled to be completed in 2007. The main goals of the study include:

- Strengthening the livestock industry.
- Protecting water quality.
- Preserving open space.

The key to success for this study is getting input and cooperation from livestock producers like you. Please take a few moments to complete the questionnaire. Additional information is located at www.danewaters.com; click on "manure management pages" and then "Community Manure Feasibility Study Committee."

Your answers to the questions will be kept confidential and will be combined with those of other producers. Once the data are compiled, we will send you a summary of the results. We will contact you only if you express an interest in working with us on manure management solutions.

Please mail the completed questionnaire to us by April 13, 2007, in the postage-prepaid envelope, or cut it in half and fax it to Rachel Lee at 251-8655. If you have any questions or suggestions, please feel free to call Randy Wirtz at Strand (251-4843) or John Reindl at Dane County (267-8815). Thanks for your help.

Sincerely,

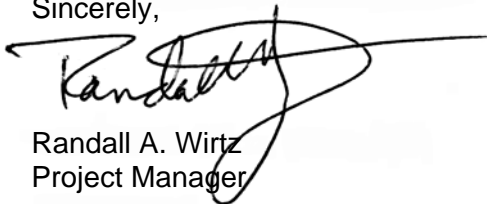
A handwritten signature in black ink, appearing to read "Randall", with a large, sweeping flourish extending to the right.

Randall A. Wirtz
Project Manager

Enclosure

Dane County Manure Management Survey April 2007

Please answer all of the questions to the best of your ability. Any information provided will be kept strictly confidential. A summary of survey results will be provided to all respondents. Mail your questionnaire by April 13, 2007 to: Strand Associates, Inc., 910 West Wingra Drive, Madison, WI 53715 or fax it to Rachel Lee, 251-8655. Thanks for your help!

1. What do you see as your greatest farming challenges now and in five to ten years? **[CHECK ALL THAT APPLY.]**

NOW FUTURE

- Prices received for grain, milk and livestock
- Cost of land in competition with urban development
- Cost of inputs for grain and livestock production
- Disposal of livestock manure (handling, storing & spreading)
- Environmental laws and restrictions (odor, water quality, development)
- Federal agricultural policies
- Other _____
- Other _____

2. Please indicate how many acres of each crop you grow. Then enter how many acres of each receive manure.

Crop	Acres Grown in 2006	Acres Owned Now Used for Manure Application	Acres Owned by Others Now Used for Manure Application
Corn for grain and silage			
Soybeans			
Small grains			
Alfalfa, clover & other forage crops			
Vegetables			
Pasture			
All other crops			
TOTAL ACRES			

3. How many head of livestock are you now raising on all of your farm sites? Plan for 2008? Plan for 2012?

	Dairy Milking Cows	Dairy Dry Cows	Other Adult Dairy	Adult Beef	Adult Swine	Young Stock *	Total Poultry	Other (describe)
2007 Current								
2008 Next Year								
2012 Five Years								

* Young stock should include all dairy and beef calves, as well as pigs under 100 pounds. Do not include them in previous counts for adult livestock. Other should include horses, mules, ponies, sheep, goats, llamas, alpacas, etc.

4. How much livestock manure is generated each year on all of your farms? **[ENTER ESTIMATES FOR EACH TYPE.]**

LIQUIDS: _____ gal/year
 SOLIDS: _____ cubic yards/year
 SOLIDS: _____ tons/year

5. What is your current method of manure collection, solids separation, and treatment (if any)? **[CHECK ALL THAT APPLY.]**

- Scraped or pushed into a pile
- Scraped or pushed into a pit or tank
- Flushed or pumped into a pit or tank
- Other: _____

6. What is the type and volume size of your manure storage?

<u>TYPE</u>	<u>VOLUME</u>	<u>CHECK ONE</u>
<input type="checkbox"/> Unlined lagoon	_____	<input type="checkbox"/> gallons or <input type="checkbox"/> months
<input type="checkbox"/> Lined lagoon	_____	<input type="checkbox"/> gallons or <input type="checkbox"/> months
<input type="checkbox"/> Slurry tank	_____	<input type="checkbox"/> gallons or <input type="checkbox"/> months
<input type="checkbox"/> Concrete wall pit	_____	<input type="checkbox"/> gallons or <input type="checkbox"/> months
<input type="checkbox"/> Pile on ground	_____	<input type="checkbox"/> cubic yards or <input type="checkbox"/> months
<input type="checkbox"/> Store in spreader and frequently haul	_____	<input type="checkbox"/> gallons or <input type="checkbox"/> days
<input type="checkbox"/> Don't have any manure storage		

7. What is your main method(s) for applying manure to the land? **[CHECK ALL THAT APPLY.]**

- Honey wagon Manure spreader Irrigation system Other _____
 Incorporated into soil within 72 hours

8a. What is the maximum distance that you now haul manure? _____ MILES

8b. Would you be willing to increase the maximum hauling distance if a manure processing station were available in your area?

- Definitely yes Probably yes Not sure Probably not Definitely not

9a. What types and amounts of animal bedding do you use in a year?

<u>TYPE</u>	<u>VOLUME</u>	<u>CHECK ONE</u>
<input type="checkbox"/> Sand	_____	<input type="checkbox"/> cubic yards or <input type="checkbox"/> tons
<input type="checkbox"/> Straw	_____	<input type="checkbox"/> bales or <input type="checkbox"/> tons
<input type="checkbox"/> Corn stalks/soybean stubble	_____	<input type="checkbox"/> bales or <input type="checkbox"/> tons
<input type="checkbox"/> Saw dust/wood chips	_____	<input type="checkbox"/> cubic yards or <input type="checkbox"/> tons
<input type="checkbox"/> Other _____	_____	<input type="checkbox"/> _____ or <input type="checkbox"/> _____

9b. How much do you spend each year on bedding purchased from others? _____ DOLLARS

10a. How much water do you use in your livestock operation? _____ GALLONS/YEAR

10b. How much do you spend for electricity to pump water? _____ DOLLARS/YEAR

11. How many labor hours are spent annually by you or your hired help on the following manure management tasks?

HOURS PER YEAR

- _____ hrs. for **collecting** manure
 _____ hrs. for **storing** manure
 _____ hrs. for **hauling** manure
 _____ hrs. for **applying** manure to fields
 _____ hrs. for **maintaining** manure related equipment
 _____ hrs. for **doing paperwork** for nutrient management plans, documentation, etc.
 _____ hrs. for **other** manure related tasks
 _____ hrs. **TOTAL**

12a. Do you have a nutrient management plan? Yes No

12b. If land application of manure is based on P rather than N, do you have enough land? Yes No

12c. If NO to Q.12b, how many additional acres of land do you think you need? _____ ACRES

12d. Are manure disposal requirements limiting plans for expanding your livestock operation? Yes No

13. Please indicate your level of concern with the following aspects of manure management. Circle 5=VERY CONCERNED, 4=SOMEWHAT CONCERNED, 3=NEUTRAL, 2=SOMEWHAT UNCONCERNED, and 1=NOT AT ALL CONCERNED, or 9=NOT APPLICABLE. [BE SURE TO RATE EACH ASPECT.]

	<u>VERY CONCERNED</u>	<u>SOMEWHAT CONCERNED</u>	<u>NEUTRAL</u>	<u>SOMEWHAT UNCONCERNED</u>	<u>NOT AT ALL CONCERNED</u>	<u>NOT APPLICABLE</u>
a. Odor or bad smells.....	5	4	3	2	1	9
b. Local water quality.....	5	4	3	2	1	9
c. Hauling on highways.....	5	4	3	2	1	9
d. Residential development.....	5	4	3	2	1	9
e. Spreading regulations.....	5	4	3	2	1	9

14. Do you or someone else plan to continue operating this place as a farm in the future? If NO, please explain.

- a. 1-4 years Yes No Don't Know Comments: _____
- b. 5-9 years..... Yes No Don't Know Comments: _____
- c. 10+ years..... Yes No Don't Know Comments: _____

15. What obstacles do you think would need to be overcome before farmers would accept a community manure processor that served many livestock operations?

16. This Dane County Manure Management Feasibility Study will be completed in 2007. Please indicate below your possible interest in helping with this study.

- Yes, I am interested in exploring individual farm solutions to nutrient and manure management
- Yes, I am interested in exploring potential "farm cluster" or community solutions with other farmers
- Yes, but I would like to get more information about the study first [SEE CONTACT NAMES BELOW.]
- No for now, but check back with me at a later date
- No, not at all interested
- No, but talk with this family member or neighbor to see if they are interested:
NAME _____ PHONE NUMBER _____

Thank you very much for your help. Please provide the following information so that we can send you a summary of the survey results or contact you about helping with the feasibility study.

Owner/Operator's Name: _____ Corporate or Farm Name: _____

Road or PO Box Address: _____ Town _____ ZIP _____

Address(es) of Livestock Operations (if different from mailing address):

Road or PO Box Address: _____ Town _____ ZIP _____

Road or PO Box Address: _____ Town _____ ZIP _____

Phone Number: _____ E-mail Address: _____

Preferred Method of Contact: Phone E-mail US Mail On farm visit

PLEASE USE THIS SPACE OR THE BACK OF THIS PAGE TO ADD ANY COMMENTS YOU WOULD LIKE TO MAKE ABOUT THE IDEA OF HAVING A COMMUNITY MANURE PROCESSOR, GETTING COOPERATION OF LIVESTOCK PRODUCERS, OR ANYTHING ELSE RELATED TO PROTECTING FARMLAND AND WATER QUALITY IN YOUR AREA. IF YOU NEED MORE INFORMATION, FEEL FREE TO CONTACT: RANDY WIRTZ AT STRAND (252-4843) OR JOHN REINDL AT DANE COUNTY (267-8815).

ADDITIONAL COMMENTS

Dane County Study Observations and Recommendations

End of project report submitted to Strand Associates, Oct 2nd, 2007.

This report serves as a summary of the findings carried out by UW-Platteville faculty for a preliminary study on the removal of phosphorus from manure samples via chemical means. The samples studied were collected from three different dairy farms with two different types of digesters (mesophilic and thermophilic). The following salts were tested for the chemical removal of phosphorus: FeSO₄, Fe₃(SO₄)₂, MgSO₄, and Al₃(SO₄)₂.

Samples of approximately 200 ml of manure were placed in 600 ml beakers, to which the chemical solution was added. To a varying degree, frothing of the samples occurred after chemical addition. Samples were continuously mixed for three days, a relatively long period, to aid in the dissipation of the frothing. Then the samples were allowed to settle for two days. After settling, the supernatant was decanted for analysis. The remaining sample was centrifuged at 15,000 rpm (or 17,640 rcf) for 15 minutes, with analyses performed on the centrate.

Removal by Iron (III) Sulfate

The most significant tests were carried out using three samples collected at Quantum Dairy in Weyauwega, WI. This dairy farm uses a mesophilic digester installed by GHD Engineering based in Chilton, WI. The samples were analyzed or treated within a week of collection and stored at 4 °C before use. The three samples were untreated manure, digested manure, and the liquid fraction of digested manure. Removal efficiencies at Fe:P molar ratios on the order of 3:1-4:1 are summarized in Table 1.

Table 1. Removal Efficiencies Using Iron (III) Sulfate

Type of Manure	Separation Method	% Total P	% Soluble P	% TKN	% Total Solids	% Volatile Solids
Raw Manure	Decant	75	97	61	67	88
	Centrifuged	64	96	61	67	83
Digested Total Manure	Decant	57	96	47	55	68
	Centrifuge	82	98	49	62	76
Digested Liquid Portion	Decant	79	98	47	33	51
	Centrifuge	86	99	49	40	67

Soluble P removal efficiencies are very high, greater than 95% in all cases. However, total P removal efficiencies were in some cases much lower, ranging from 57% to 86%. This less efficient removal is attributed to colloidal P, which for the digested manures, was increasingly removed by centrifugation. With the exception of total P, removal efficiencies were similar for both methods of separation, as would be expected for constituents that are dissolved (unaffected by centrifugation) or associated with larger (noncolloidal) particulates that readily settle. Note that total solids analyses include both suspended and dissolved solids and the relatively low removal efficiencies result from dissolved solids remaining in solution. The manure:iron salt mixtures exhibited excellent settleability, the supernatant had very low turbidity (transparent). However, some particulates did remain in solution and some additional particulates were resuspended during the decanting procedure.

Centrifugation is more efficient at particulate removal, with less resuspension occurring during decanting.

Removal by Iron (II) Sulfate or Magnesium Sulfate

For these initial tests excessive metal addition occurred as a result of miscalculation, with Fe:P molar ratios of up to 38. Removal efficiencies were relatively high for both chemicals (Fe or Mg), however settling was less effective due to colloidal formation for the magnesium. The magnesium solution remained cloudy even after the two day settling period. For Fe⁺², an intermittent layer (white in color) between the supernatant and the settled solids that formed could be iron carbonate. This layer was not analyzed for P content or present in the other test solutions.

Frothing

In some of these samples excessive frothing occurs and forms a layer of ~ 3 times the size in solution; a 200 ml solution would make a 600 ml layer of froth (needed a larger beaker for these samples). This frothing occurs when aluminum sulfate or iron (III) sulfate is added in liquid or solid form. The frothing does not occur when magnesium sulfate, iron (II) sulfate or acid (tested as a control) is added. At this time, the gas released that is responsible for the frothing is assumed to be carbon dioxide. The gas is odorless and is not flammable.

Transferability of results

The removal efficiencies presented serve as a preliminary indicator of the effectiveness of iron (III) as a coagulant. Actual removal efficiencies would be expected to vary depending on specific farm practices, such as, but not limited to: type of livestock, feed ration, bedding type, manure collection system, and post-collection treatment/storage.

Conclusion

The addition of iron salts is shown to be an effective way to remove phosphorus, nitrogen and volatile (organic) solids from both untreated and digested dairy manure. Total phosphorus was removed at an average of 75% using a 3:1 Fe⁺³:P molar ratio. This same ratio removed 97% of the soluble P as well as over 50% of the volatile solids and TKN (organic N and ammonia). This suggests the potential for using removed solids as a nutrient source for off-site use. However, several potential issues remain unanswered:

- Is the phosphorus removed by iron salts bioavailable?
- What are the costs of slurry versus dried solids?
- Do markets exist for the removed solids?

Dane County Manure Management Study

Opinion of Costs

Alternative F-1

Fine Solids Separation with Polymer Addition

Opinion of Capital Costs	Initial Capital Cost
Raw Manure Short-Term Storage	\$20,000
Fine Solids Separation	\$228,000
Solids Conveyor	\$20,000
Solids Storage	\$53,000
Liquids Transfer Pumping Station	\$20,000
Liquids Storage	\$108,000
Building for Solids Separation (40x40)	\$160,000
Non-Potable Water System - Tank and Pumps	\$50,000
Subtotal	\$659,000
Piping and Mechanical	\$66,000
Electrical	\$66,000
HVAC	\$33,000
Site Work	\$33,000
Subtotal	\$857,000
Contractors General Conditions	\$69,000
Construction Costs	\$926,000
Contingencies & Technical Services	\$370,000
Total Project Costs	\$1,296,000
Decommissioning Reserve	\$130,000
Total Opinion of Capital Cost	\$1,426,000

Opinion of Annual O&M Costs	Year 2007	Year 2012	Year 2012 + 25%
Labor	\$42,000	\$47,000	\$51,700
Electricity	\$5,000	\$5,000	\$6,000
Natural Gas	\$5,000	\$6,000	\$6,000
Liquid Hauling Costs	\$67,000	\$76,000	\$91,200
Solids Disposal Revenue	(\$7,000)	(\$8,000)	(\$10,000)
GHG Emission Reduction Credits	(\$5,000)	(\$11,000)	(\$13,800)
Energy Credit and RECs	\$0	\$0	\$0
Chemicals	\$35,000	\$39,000	\$48,800.00
Maintenance and Supplies	\$10,000	\$11,000	\$12,700
Total Annual O&M Costs	\$152,000	\$165,000	\$193,000

Dane County Manure Management Study

Opinion of Costs

Alternative F-2

Fine Solids Separation with Ferric Chloride and Polymer Addition

Opinion of Capital Costs	Initial Capital Cost		
Raw Manure Short-Term Storage	\$20,000		
Fine Solids Separation	\$241,000		
Solids Conveyor	\$20,000		
Solids Storage	\$18,000		
Liquids Transfer Pumping Station	\$20,000		
Liquids Lagoon Modifications	\$27,000		
Building for Solids Separation (40 x 40)	\$160,000		
Non-Potable Water System - Tank and Pumps	\$50,000		
Irrigation Equipment and Piping	\$223,000		
Subtotal	\$779,000		
Piping and Mechanical	\$78,000		
Electrical	\$78,000		
HVAC	\$39,000		
Site Work	\$39,000		
Subtotal	\$1,013,000		
Contractors General Conditions	\$81,000		
Construction Costs	\$1,094,000		
Contingencies & Technical Services	\$438,000		
Total Project Costs	\$1,532,000		
Decommissioning Reserve	\$153,000		
Total Opinion of Capital Cost	\$1,685,000		
Opinion of Annual O&M Costs	Year 2007	Year 2012	Year 2012 + 25%
Labor	\$42,000	\$47,000	\$51,700
Electricity	\$5,000	\$6,000	\$7,200
Natural Gas	\$5,000	\$6,000	\$6,000
Liquid Hauling Costs (spray irrigation costs included elsewhere)	\$0	\$0	\$0
Solids Disposal Revenue	(\$28,000)	(\$31,000)	(\$38,800)
GHG Emission Reduction Credits	(\$11,000)	(\$23,000)	(\$28,800)
Energy Credit and RECs	\$0	\$0	\$0
Chemicals	\$25,000	\$25,000	\$31,300.00
Maintenance and Supplies	\$15,000	\$17,000	\$19,600
Total Annual O&M Costs	\$53,000	\$47,000	\$48,000

Dane County Manure Management Study

Opinion of Costs

Alternative F-3

Anaerobic Digestion; Fine Solids Separation with Ferric Chloride and Polymer Addition

Opinion of Capital Costs	Initial Capital Cost		
Raw Transfer Pumping Station	\$20,000		
Anaerobic Digester and GenSet	\$400,000		
Fine Solids Separation	\$208,000		
Solids Conveyor	\$20,000		
Solids Storage	\$12,000		
Liquids Transfer Pumping Station	\$20,000		
Building for Solids Separation and AD Controls (60x60)	\$360,000		
Non-Potable Water System - Tank and Pumps	\$50,000		
Irrigation Equipment and Piping	\$223,000		
Subtotal	\$1,313,000		
Piping and Mechanical	\$131,000		
Electrical	\$131,000		
HVAC	\$66,000		
Site Work	\$66,000		
Subtotal	\$1,707,000		
Contractors General Conditions	\$137,000		
Construction Costs	\$1,844,000		
Contingencies & Technical Services	\$738,000		
Total Project Costs	\$2,582,000		
Decommissioning Reserve	\$258,000		
Total Opinion of Capital Cost	\$2,840,000		
Opinion of Annual O&M Costs	Year 2007	Year 2012	Year 2012 + 25%
Labor	\$83,000	\$94,000	\$103,400
Electricity	\$24,000	\$27,000	\$32,400
Natural Gas	\$0	\$0	\$0
Liquid Hauling Costs (spray irrigation costs included elsewhere)	\$0	\$0	\$0
Solids Disposal Revenue	(\$38,000)	(\$44,000)	(\$55,000)
GHG Emission Reduction Credits	(\$12,000)	(\$24,000)	(\$30,000)
Energy Credit and RECs	(\$23,000)	(\$25,000)	(\$31,300)
Chemicals	\$25,000	\$25,000	\$31,300
Maintenance and Supplies	\$23,000	\$25,000	\$28,800
Total Annual O&M Costs	\$82,000	\$78,000	\$80,000

Dane County Manure Management Study

Opinion of Costs

Alternative C-1 W

Fine Solids Separation with Polymer

Opinion of Capital Costs	Initial Capital Cost
Individual Farm Costs	
Farm 32	
Raw Manure Force Main	\$30,000
Raw Manure Pumping Station	\$27,000
Farm 4	
Raw Manure Force Main	\$210,000
Raw Manure Storage Tank (Six Months)	\$162,000
Raw Manure Pumping Station	\$27,000
Farm 150	
Raw Manure Force Main	\$105,000
Raw Manure Storage Tank (Short-Term)	\$27,000
Raw Manure Pumping Station	\$27,000
Community Site Costs	
Raw Manure Storage	\$203,000
Fine Solids Separation	\$937,000
Solids Conveyor	\$20,000
Solids Storage	\$531,000
Liquids Transfer Pumping Station	\$34,000
Liquids Storage	\$243,000
Liquids Return Pumping Station	\$47,000
Non-Potable Water System - Tank and Pumps	\$100,000
Building for Solids Separation, Maintenance, and Controls (60x40)	<u>\$240,000</u>
Subtotal	\$2,970,000
Piping and Mechanical	
Piping and Mechanical	\$297,000
Electrical	\$297,000
HVAC	\$149,000
Site Work	<u>\$149,000</u>
Subtotal	\$3,862,000
Contractors General Conditions	
Contractors General Conditions	\$309,000
Construction Costs	\$4,171,000
Contingencies & Technical Services	<u>\$1,668,000</u>
Total Project Costs	\$5,839,000
Decommissioning Reserve	
Decommissioning Reserve	\$584,000
Total Opinion of Capital Cost	\$6,423,000

Opinion of Annual O&M Costs	Year 2007	Year 2012	Year 2012 + 25%
Labor	\$166,000	\$187,000	\$205,700
Electricity	\$17,000	\$19,000	\$22,800
Natural Gas	\$10,000	\$11,000	\$11,000
Liquid Hauling Costs	\$557,000	\$630,000	\$756,000
Solids Disposal Revenue	(\$67,000)	(\$81,000)	(\$101,300)
GHG Emission Reduction Credits	(\$53,000)	(\$107,000)	(\$133,800)
Energy Credit and RECs	\$0	\$0	\$0
Chemicals	\$349,000	\$395,000	\$493,800.00
Maintenance and Supplies	\$28,000	\$32,000	\$36,800
Total Annual O&M Costs	\$1,007,000	\$1,086,000	\$1,291,000

Dane County Manure Management Study

Opinion of Costs

Alternative C-1 M

Fine Solids Separation with Polymer

Opinion of Capital Costs	Initial Capital Cost
<hr/>	
Individual Farm Costs	
Farm 89	
Raw Manure Storage (Short-Term)	\$27,000
Farm 142	
Raw Manure Storage (Short-Term)	\$27,000
Farm 156	
Liquid Residual Storage (Six Months)	\$100,000
Farm 176	
Raw Manure Storage (Short-Term)	\$27,000
Farm 195	
Raw Manure Storage (Short-Term)	\$27,000
Community Site Costs	
Raw Manure Storage	\$162,000
Fine Solids Separation	\$963,000
Solids Conveyor	\$20,000
Solids Storage	\$396,000
Liquids Transfer Pumping Station	\$34,000
Liquids Storage	\$167,000
Non-Potable Water System - Tank and Pumps	\$100,000
Building for Solids Separation, Maintenance, and Controls (80x40)	<u>\$320,000</u>
Subtotal	\$2,370,000
Piping and Mechanical	\$237,000
Electrical	\$237,000
HVAC	\$119,000
Site Work	<u>\$119,000</u>
Subtotal	\$3,082,000
Contractors General Conditions	\$247,000
Construction Costs	\$3,329,000
Contingencies & Technical Services	<u>\$1,332,000</u>
Total Project Costs	<u>\$4,661,000</u>
Decommissioning Reserve	\$466,000
Total Opinion of Capital Cost	\$5,127,000

Opinion of Annual O&M Costs	Year 2007	Year 2012	Year 2012 + 25%
Labor	\$166,000	\$187,000	\$205,700
Electricity	\$15,000	\$17,000	\$20,400
Natural Gas	\$10,000	\$11,000	\$11,000
Liquid Hauling Costs	\$558,000	\$631,000	\$757,200
Solids Disposal Revenue	(\$50,000)	(\$60,000)	(\$75,000)
GHG Emission Reduction Credits	(\$40,000)	(\$80,000)	(\$100,000)
Energy Credit and RECs	\$0	\$0	\$0
Chemicals	\$259,000	\$293,000	\$366,300.00
Maintenance and Supplies	\$28,000	\$32,000	\$36,800
Total Annual O&M Costs	\$946,000	\$1,031,000	\$1,222,000

Dane County Manure Management Study

Opinion of Costs

Alternative C-2W

Fine Solids Separation with Ferric Chloride and Polymer Addition

Opinion of Capital Costs	Initial Capital Cost		
Individual Farm Costs			
Farm 32			
Raw Manure Force Main	\$30,000		
Raw Manure Pumping Station	\$27,000		
Irrigation Equipment and Piping	\$382,000		
Farm 4			
Raw Manure Force Main	\$210,000		
Raw Manure Storage Tank (Six Months)	\$162,000		
Raw Manure Pumping Station	\$27,000		
Irrigation Equipment and Piping	\$382,000		
Farm 150			
Raw Manure Force Main	\$105,000		
Raw Manure Storage Tank (Short-Term)	\$27,000		
Raw Manure Pumping Station	\$27,000		
Irrigation Equipment and Piping	\$382,000		
Community Site Costs			
Raw Manure Storage	\$203,000		
Ferric Chloride Bulk Storage	\$20,000		
Fine Solids Separation	\$911,000		
Solids Conveyor	\$20,000		
Solids Storage	\$388,000		
Liquids Transfer Pumping Station	\$34,000		
Liquids Storage	\$167,000		
Liquids Return Pumping Station	\$47,000		
Non-Potable Water System - Tank, Pumps, and Filter	\$100,000		
Building for Solids Separation, Maintenance, and Controls (60x40)	\$240,000		
Subtotal	\$3,891,000		
Piping and Mechanical	\$389,000		
Electrical	\$389,000		
HVAC	\$195,000		
Site Work	\$195,000		
Subtotal	\$5,059,000		
Contractors General Conditions	\$405,000		
Construction Costs	\$5,464,000		
Contingencies & Technical Services	\$2,186,000		
Total Project Costs	\$7,650,000		
Decommissioning Reserve	\$765,000		
Total Opinion of Capital Cost	\$8,415,000		
Opinion of Annual O&M Costs			
	Year 2007	Year 2012	Year 2012 + 25%
Labor	\$166,000	\$187,000	\$205,700
Electricity	\$17,000	\$19,000	\$22,800
Natural Gas	\$10,000	\$11,000	\$11,000
Liquid Hauling Costs (spray irrigation costs included elsewhere)	\$0	\$0	\$0
Solids Disposal Revenue	(\$283,000)	(\$312,000)	(\$390,000)
GHG Emission Reduction Credits	(\$113,000)	(\$226,000)	(\$282,500)
Energy Credit and RECs	\$0	\$0	\$0
Chemicals	\$250,000	\$283,000	\$353,800.00
Maintenance and Supplies	\$51,000	\$58,000	\$66,700
Total Annual O&M Costs	\$98,000	\$20,000	(\$13,000)

Dane County Manure Management Study

Opinion of Costs

Alternative C-2 M

Fine Solids Separation with Ferric Chloride and Polymer Addition

Opinion of Capital Costs	Initial Capital Cost
Individual Farm Costs	
Farm 89	
Raw Manure Storage (Short-Term)	\$27,000
Irrigation Equipment and Piping	\$303,000
Farm 142	
Raw Manure Storage (Short-Term)	\$27,000
Irrigation Equipment and Piping	\$303,000
Farm 156	
Liquid Residual Storage (Six Months)	\$74,000
Irrigation Equipment and Piping	\$303,000
Farm 176	
Raw Manure Storage (Short-Term)	\$27,000
Irrigation Equipment and Piping	\$303,000
Farm 195	
Raw Manure Storage (Short-Term)	\$27,000
Irrigation Equipment and Piping	\$303,000
Community Site Costs	
Raw Manure Storage	\$162,000
Ferric Chloride Bulk Storage	\$20,000
Fine Solids Separation	\$1,031,000
Solids Conveyor	\$20,000
Solids Storage	\$291,000
Liquids Transfer Pumping Station	\$34,000
Liquids Storage	\$124,000
Non-Potable Water System - Tank, Pumps, and Filter	\$100,000
Building for Solids Separation, Maintenance, and Controls (80x40)	\$320,000
Subtotal	<u>\$3,799,000</u>
Piping and Mechanical	\$380,000
Electrical	\$380,000
HVAC	\$190,000
Site Work	\$190,000
Subtotal	<u>\$4,939,000</u>
Contractors General Conditions	\$395,000
Construction Costs	\$5,334,000
Contingencies & Technical Services	\$2,134,000
Total Project Costs	<u><u>\$7,468,000</u></u>
Decommissioning Reserve	\$747,000
Total Opinion of Capital Cost	<u>\$8,215,000</u>

Opinion of Annual O&M Costs	Year 2007	Year 2012	Year 2012 + 25%
Labor	\$166,000	\$187,000	\$205,700
Electricity	\$15,000	\$17,000	\$20,400
Natural Gas	\$10,000	\$11,000	\$11,000
Liquid Hauling Costs (spray irrigation costs included elsewhere)	\$459,000	\$519,000	\$622,800
Solids Disposal Revenue	(\$212,000)	(\$233,000)	(\$291,300)
GHG Emission Reduction Credits	(\$84,000)	(\$168,000)	(\$210,000)
Energy Credit and RECs	\$0	\$0	\$0
Chemicals	\$186,000	\$211,000	\$263,800.00
Maintenance and Supplies	\$60,000	\$68,000	\$78,200
Total Annual O&M Costs	<u>\$600,000</u>	<u>\$612,000</u>	<u>\$701,000</u>

Dane County Manure Management Study Opinion of Costs

Alternative C-3W

Anaerobic Digestion Followed by Fine Solids Separation with Ferric Chloride and Polymer Addition

Opinion of Capital Costs	Initial Capital Cost		
Individual Farm Costs			
Farm 32			
Raw Manure Force Main	\$30,000		
Raw Manure Pumping Station	\$27,000		
Irrigation Equipment and Piping	\$382,000		
Farm 4			
Raw Manure Force Main	\$210,000		
Raw Manure Storage Tank (Six Months)	\$162,000		
Raw Manure Pumping Station	\$27,000		
Irrigation Equipment and Piping	\$382,000		
Farm 150			
Raw Manure Force Main	\$105,000		
Raw Manure Storage Tank (Short-Term)	\$27,000		
Raw Manure Pumping Station	\$27,000		
Irrigation Equipment and Piping	\$382,000		
Community Site Costs			
Raw Manure Storage	\$203,000		
Raw Transfer Station	\$34,000		
Anaerobic Digester and GenSet	\$1,717,000		
Ferric Chloride Bulk Storage	\$20,000		
Fine Solids Separation	\$644,000		
Solids Conveyor	\$20,000		
Solids Storage	\$264,000		
Liquids Transfer Pumping Station	\$34,000		
Liquids Storage	\$151,000		
Liquids Return Pumping Station	\$47,000		
Non-Potable Water System - Tank and Pumps	\$100,000		
Building for Solids Separation, Maintenance, and Controls (80x40)	\$320,000		
Subtotal	\$5,315,000		
Piping and Mechanical	\$532,000		
Electrical	\$532,000		
HVAC	\$266,000		
Site Work	\$266,000		
Subtotal	\$6,911,000		
Contractors General Conditions	\$553,000		
Construction Costs	\$7,464,000		
Contingencies & Technical Services	\$2,986,000		
Total Project Costs	\$10,450,000		
Decommissioning Reserve	\$1,045,000		
Total Opinion of Capital Cost	\$11,495,000		
Opinion of Annual O&M Costs			
	Year 2007	Year 2012	Year 2012 + 25%
Labor	\$166,000	\$187,000	\$205,700
Electricity	\$103,000	\$113,000	\$135,600
Natural Gas	\$0	\$0	\$0
Liquid Hauling Costs (spray irrigation costs included elsewhere)	\$0	\$0	\$0
Solids Disposal Revenue	(\$388,000)	(\$446,000)	(\$557,500)
GHG Emission Reduction Credits	(\$119,000)	(\$238,000)	(\$297,500)
Energy Credit and RECs	(\$231,000)	(\$248,000)	(\$310,000)
Chemicals	\$170,000	\$193,000	\$241,300
Maintenance and Supplies	\$79,000	\$89,000	\$102,400
Total Annual O&M Costs	(\$220,000)	(\$350,000)	(\$480,000)

Dane County Manure Management Study Opinion of Costs

Alternative C-3 M

Anaerobic Digestion Followed by Fine Solids Separation with Ferric Chloride and Polymer Addition

Opinion of Capital Costs	Initial Capital Cost		
Individual Farm Costs			
Farm 89			
Raw Manure Storage (Short-Term)	\$27,000		
Irrigation Equipment and Piping	\$303,000		
Farm 142			
Raw Manure Storage (Short-Term)	\$27,000		
Irrigation Equipment and Piping	\$303,000		
Farm 156			
Liquid Residual Storage (Six Months)	\$62,000		
Irrigation Equipment and Piping	\$303,000		
Farm 176			
Raw Manure Storage (Short-Term)	\$27,000		
Irrigation Equipment and Piping	\$303,000		
Farm 195			
Raw Manure Storage (Short-Term)	\$27,000		
Irrigation Equipment and Piping	\$303,000		
Community Site Costs			
Raw Manure Storage	\$162,000		
Raw Transfer Station	\$34,000		
Anaerobic Digester and GenSet	\$1,735,000		
Ferric Chloride Bulk Storage	\$20,000		
Fine Solids Separation	\$644,000		
Solids Conveyor	\$20,000		
Solids Storage	\$199,000		
Liquids Transfer Pumping Station	\$34,000		
Liquids Storage	\$103,000		
Non-Potable Water System - Tank and Pumps	\$100,000		
Building for Solids Separation, Maintenance, and Controls (80x40)	\$320,000		
Subtotal	\$5,056,000		
Piping and Mechanical	\$506,000		
Electrical	\$506,000		
HVAC	\$253,000		
Site Work	\$253,000		
Subtotal	\$6,574,000		
Contractors General Conditions	\$526,000		
Construction Costs	\$7,100,000		
Contingencies & Technical Services	\$2,840,000		
Total Project Costs	\$9,940,000		
Decommissioning Reserve	\$994,000		
Total Opinion of Capital Cost	\$10,934,000		
Opinion of Annual O&M Costs			
	Year 2007	Year 2012	Year 2012 + 25%
Labor	\$166,000	\$187,000	\$205,700
Electricity	\$91,000	\$100,000	\$120,000
Natural Gas	\$0	\$0	\$0
Liquid Hauling Costs (spray irrigation costs included elsewhere)	\$396,000	\$448,000	\$537,600
Solids Disposal Revenue	(\$290,000)	(\$333,000)	(\$416,300)
GHG Emission Reduction Credits	(\$89,000)	(\$178,000)	(\$222,500)
Energy Credit and RECs	(\$172,000)	(\$185,000)	(\$231,300)
Chemicals	\$128,000	\$145,000	\$181,300
Maintenance and Supplies	\$74,000	\$84,000	\$96,600
Total Annual O&M Costs	\$304,000	\$268,000	\$271,000

Dane County Manure Management Study Opinion of Costs

Alternative C-4W

Fine Solids Separation with Ferric Chloride and Polymer Addition Followed by a Solids Drier/Pelletizer

Opinion of Capital Costs	Initial Capital Cost		
Individual Farm Costs			
Farm 32			
Raw Manure Force Main	\$30,000		
Raw Manure Pumping Station	\$27,000		
Irrigation Equipment and Piping	\$382,000		
Farm 4			
Raw Manure Force Main	\$210,000		
Raw Manure Storage Tank (Six Months)	\$162,000		
Raw Manure Pumping Station	\$27,000		
Irrigation Equipment and Piping	\$382,000		
Farm 150			
Raw Manure Force Main	\$105,000		
Raw Manure Storage Tank (Short-Term)	\$27,000		
Raw Manure Pumping Station	\$27,000		
Irrigation Equipment and Piping	\$382,000		
Community Site Costs			
Raw Manure Storage	\$203,000		
Ferric Chloride Bulk Storage	\$20,000		
Fine Solids Separation	\$911,000		
Solids Conveyor	\$20,000		
Solids Storage	\$60,000		
Liquids Transfer Pumping Station	\$34,000		
Liquids Storage	\$167,000		
Drier/Pelletizer	\$2,386,000		
Finished Product Storage	\$138,000		
Liquids Return Pumping Station	\$47,000		
Non-Potable Water System - Tank and Pumps	\$100,000		
Building for Solids Separation, Maintenance, and Controls (80x50)	\$400,000		
 Subtotal	 \$6,247,000		
 Piping and Mechanical	 \$625,000		
Electrical	\$625,000		
HVAC	\$312,000		
Site Work	\$312,000		
 Subtotal	 \$8,121,000		
 Contractors General Conditions	 \$650,000		
Construction Costs	\$8,771,000		
Contingencies & Technical Services	\$3,508,000		
Total Project Costs	\$12,279,000		
 Decommissioning Reserve	 \$1,228,000		
 Total Opinion of Capital Cost	 \$13,507,000		
 Opinion of Annual O&M Costs			
	Year 2007	Year 2012	Year 2012 + 25%
Labor	\$166,000	\$187,000	\$205,700
Electricity	\$39,000	\$41,000	\$49,200
Natural Gas	\$729,000	\$824,000	\$1,030,000
Liquid Hauling Costs (spray irrigation costs included elsewhere)	\$0	\$0	\$0
Solids Disposal Revenue	(\$271,000)	(\$309,000)	(\$386,300)
GHG Emission Reduction Credits	(\$119,000)	(\$238,000)	(\$297,500)
Energy Credit and RECs	\$0		\$0
Chemicals	\$250,000	\$283,000	\$353,800
Maintenance and Supplies	\$90,000	\$102,000	\$117,300
Total Annual O&M Costs	\$884,000	\$890,000	\$1,072,000

Dane County Manure Management Study Opinion of Costs

Alternative C-4 M

Fine Solids Separation with Ferric Chloride and Polymer Addition Followed by a Solids Drier/Pelletizer

Opinion of Capital Costs	Initial Capital Cost		
<hr/>			
Individual Farm Costs			
Farm 89			
Raw Manure Storage (Short-Term)	\$27,000		
Irrigation Equipment and Piping	\$303,000		
Farm 142			
Raw Manure Storage (Short-Term)	\$27,000		
Irrigation Equipment and Piping	\$303,000		
Farm 156			
Liquid Residual Storage (Six Months)	\$74,000		
Irrigation Equipment and Piping	\$303,000		
Farm 176			
Raw Manure Storage (Short-Term)	\$27,000		
Irrigation Equipment and Piping	\$303,000		
Farm 195			
Raw Manure Storage (Short-Term)	\$27,000		
Irrigation Equipment and Piping	\$303,000		
Community Site Costs			
Raw Manure Storage	\$162,000		
Ferric Chloride Bulk Storage	\$20,000		
Fine Solids Separation	\$1,031,000		
Solids Conveyor	\$20,000		
Solids Storage	\$50,000		
Liquids Transfer Pumping Station	\$34,000		
Liquids Storage	\$124,000		
Drier/Pelletizer	\$2,386,000		
Finished Product Storage	\$103,000		
Non-Potable Water System - Tank and Pumps	\$100,000		
Building for Solids Separation, Maintenance, and Controls (80x50)	\$400,000		
Subtotal	\$6,127,000		
Piping and Mechanical	\$613,000		
Electrical	\$613,000		
HVAC	\$306,000		
Site Work	\$306,000		
Subtotal	\$7,965,000		
Contractors General Conditions	\$637,000		
Construction Costs	\$8,602,000		
Contingencies & Technical Services	\$3,441,000		
Total Project Costs	\$12,043,000		
Decommissioning Reserve	\$1,204,000		
Total Opinion of Capital Cost	\$13,247,000		
Opinion of Annual O&M Costs	Year 2007	Year 2012	Year 2012 + 25%
Labor	\$166,000	\$187,000	\$205,700
Electricity	\$31,000	\$33,000	\$39,600
Natural Gas	\$544,000	\$615,000	\$768,800
Liquid Hauling Costs (spray irrigation costs included elsewhere)	\$459,000	\$519,000	\$622,800
Solids Disposal Revenue	(\$202,000)	(\$231,000)	(\$288,800)
GHG Emission Reduction Credits	(\$89,000)	(\$178,000)	(\$222,500)
Energy Credit and RECs	\$0	\$0	\$0
Chemicals	\$186,000	\$210,000	\$262,500
Maintenance and Supplies	\$49,000	\$55,000	\$63,300
Total Annual O&M Costs	\$1,144,000	\$1,210,000	\$1,451,000

Dane County Manure Management Study
Opinion of Costs
 Alternative C-5W
 Manure Incineration

Opinion of Capital Costs	Initial Capital Cost		
<hr/>			
Individual Farm Costs			
Farm 32			
Raw Manure Force Main	\$30,000		
Raw Manure Pumping Station	\$27,000		
Farm 4			
Raw Manure Force Main	\$210,000		
Raw Manure Pumping Station	\$27,000		
Farm 150			
Raw Manure Force Main	\$105,000		
Raw Manure Pumping Station	\$27,000		
Community Site Costs			
Raw Manure Storage	\$203,000		
Raw Transfer Station	\$34,000		
Drying and Natural Evaporation, Combustion/Close-Coupled Gasifier, and Turbine/Generator Set	\$4,249,000		
Ash Storage	\$10,000		
Building for Solids Separation, Maintenance, and Controls (80x40)	\$320,000		
Subtotal	\$5,242,000		
Piping and Mechanical	\$524,000		
Electrical	\$524,000		
HVAC	\$262,000		
Site Work	\$262,000		
Subtotal	\$6,814,000		
Contractors General Conditions	\$545,000		
Construction Costs	\$7,359,000		
Contingencies & Technical Services	\$2,944,000		
Total Project Costs	\$10,303,000		
Decommissioning Reserve	\$1,030,000		
Total Opinion of Capital Cost	\$11,333,000		
Opinion of Annual O&M Costs	Year 2007	Year 2012	Year 2012 + 25%
Labor	\$166,000	\$187,000	\$205,700
Electricity	\$21,000	\$23,000	\$27,600
Natural Gas	\$0	\$0	\$0
Liquid Hauling Costs (spray irrigation costs included elsewhere)	\$0	\$0	\$0
Solids Disposal Revenue	(\$28,000)	(\$32,000)	(\$40,000)
GHG Emission Reduction Credits	(\$119,000)	(\$238,000)	(\$297,500)
Energy Credit and RECs	(\$310,000)	(\$334,000)	(\$417,500)
Chemicals	\$0	\$0	\$0
Maintenance and Supplies	\$87,000	\$98,000	\$112,700
Total Annual O&M Costs	(\$183,000)	(\$296,000)	(\$409,000)

Dane County Manure Management Study

Opinion of Costs

Alternative C-5 M
Manure Incineration

Opinion of Capital Costs	Initial Capital Cost
<hr/>	
Individual Farm Costs	
None	
Community Site Costs	
Raw Manure Storage	\$162,000
Raw Transfer Station	\$34,000
Drying and Natural Evaporation, Combustion/Close-Coupled Gasifier, and Turbine/Generator Set	\$4,249,000
Ash Storage	\$8,000
Building for Solids Separation, Maintenance, and Controls (80x40)	<u>\$320,000</u>
Subtotal	\$4,773,000
Piping and Mechanical	\$477,000
Electrical	\$477,000
HVAC	\$239,000
Site Work	<u>\$239,000</u>
Subtotal	\$6,205,000
Contractors General Conditions	\$496,000
Construction Costs	\$6,701,000
Contingencies & Technical Services	<u>\$2,680,000</u>
Total Project Costs	<u>\$9,381,000</u>
Decommissioning Reserve	\$938,000
Total Opinion of Capital Cost	\$10,319,000

Opinion of Annual O&M Costs	Year 2007	Year 2012	Year 2012 + 25%
Labor	\$166,000	\$187,000	\$205,700
Electricity	\$19,000	\$21,000	\$25,200
Natural Gas	\$0	\$0	\$0
Liquid Hauling Costs (manure to cluster)	\$306,000	\$346,000	\$415,200
Solids Disposal Revenue	(\$21,000)	(\$24,000)	(\$30,000)
GHG Emission Reduction Credits	(\$89,000)	(\$178,000)	(\$222,500)
Energy Credit and RECs	(\$232,000)	(\$250,000)	(\$312,500)
Chemicals	\$0	\$0	\$0
Maintenance and Supplies	\$86,000	\$97,000	\$111,600
Total Annual O&M Costs	\$235,000	\$199,000	\$193,000